

WinGuard[®] EnergyVue[®]

VINYL IMPACT
& NON-IMPACT
TECHNICAL
GUIDE



Protecting families through some of life's most demanding situations.



General Specifications4

WinGuard® Product Quick Reference Guide6

EnergyVue® Product Quick Reference Guide8

Single Hung (SH5400 & SH5500)10

Double Hung (DH5460 & DH5560)13

Horizontal Roller (HR5410 & HR5510)16

Casement (CA5440 & CA5540)19

Awning (AW5440 & AW5540)22

Fixed Lite Picture Window & Architecturals (PW & AR5420/5520, PW & AR5440/5540)25

Preferred Sliding Glass Door (SGD5570)26

Preferred French Door (FD5455 & FD5555)29



GENERAL SPECIFICATIONS

PERFORMANCE

- Tested and certified to rigorous Miami-Dade protocols and AAMA Standards
- WinGuard® Vinyl is qualified as large and small missile
- Florida Building Code approved
- Meets or exceeds international building code standards
- NFRC certified

ENERGY PERFORMANCE

- High performance Low-E glass and argon gas available
- Various heat reducing glass tints

CONTINUOUS PROTECTION

- Glass options that meet the Sea Turtle Protection Code
- Durable low maintenance vinyl frames
- WinGuard® Vinyl products also:
 - Deters intruders
 - Protects against high winds and wind-borne debris
 - Filters out 99% of UV rays and protects against damage caused by UV rays
 - Reduces outside noise

FEATURES

- Custom built to homeowners' specifications

RESIDENTIAL WARRANTY

- Limited lifetime* frame coverage

STYLES

- Single Hung
- Double Hung
- Horizontal Roller
- Casement
- Projected Awning
- Picture Window
- Architectural Shapes
- Sliding Glass Doors
- French Doors
- Mull Bars and Mull Clips

FRAMES

- Heavy-duty extruded vinyl
- Nominal 3-1/4" window frame depth
- 5/8" Flange frame type with all windows
- Integral Nail-Fin, J-Channel and Equal Leg frame types available

*Some restrictions may apply. Refer to full PGT Custom Windows + Doors warranty for complete details.

GLAZING

- WinGuard® Vinyl: Impact resistant laminated insulating glass
- EnergyVue® Vinyl: Insulating glass
- All products are exterior glazed
- All products are silicone glazed for greater strength and seal

FRAME COLORS

- Standard: White
- Optional: Beige, Bronze Exterior/White Interior, Bronze Exterior/Bronze Interior, Black Exterior/White Interior, Black Exterior/Black Interior
- Custom colors available

GLASS OPTIONS

- Standard Tints: Bronze, Gray, Green
- Premium Tints: Solar Cool Bronze, Azure Blue
- Low-E: EnergyShield™, EnergyShield™ Max
- Privacy Glass: Obscure Glass, White Interlayer also available on WinGuard® Vinyl
- Argon gas

COLONIAL GRIDS

Colonial Insulating:

- 9/16" Flat grids between the glass
- 13/16" Flat grids between the glass
- 1" Contour grids between the glass

Simulated Divided Lite:

- 7/8" Ogee raised exterior and interior grid with 9/16" bronze shadow bar between glass

OPENING SIZES

Window Opening Size Formulas

Openings are calculated using 1/8" shim space (maximum 1/4" allowed)

Masonry Opening with 1x Bucks and Precast Sill	Masonry Opening with 1x Bucks and Poured Sill	Wood Frame Opening with Drywall Butted
Actual Window Width + 1-3/4"	Actual Window Width + 1-3/4"	Actual Window Width + 1/4"
Actual Window Height + 1"	Actual Window Height + 1-3/4"	Actual Window Height + 1/4"

French Door and By-Pass Sliding Glass Door Finished Opening Size Formulas

Openings calculated using 1/8" shim space (maximum 1/4" allowed)

Masonry Opening with No Bucks:	Masonry Opening with 1x Bucks:	Masonry Opening with 2x Bucks:
Door Width + 1/4"	Door Width + 1-3/4"	Door Width + 3-1/4"
Door Height + 1/8"	Door Height + 7/8"	Door Height + 1-5/8"

Visit ProZone to order our convenient opening size chart pocket cards.

Note: PGT® reserves the right to change material design and/or construction without notice or liability.

WINGUARD® VINYL PRODUCT QUICK REFERENCE GUIDE

Product Styles and Sizes					Frame Styles				Test Methods and Certifications					
Product Style	Configuration	Nominal Frame Depth	Minimum Size (actual DLO frame size)	Maximum Size (actual DLO frame size)	5/8" Flange	Integral Nail Fin**	J-Channel**	Equal Leg	AAMA A440 & ASTM E1886/1996		TAS 201 / 202 / 203		Florida Product Approval ENERGY STAR®	
									Design Pressure	Keystone Certification	Design Pressure	Miami-Dade NOA		
Single Hung (SH5500)	O/X Equal	3-1/2"	16-1/4" x 25-1/4"	52-1/8" x 84"	■	■	■	■	+65/-70	■			■	■
				54" x 84"			+70/-110	■						
	O/X Proview	3-1/2"	16-1/4" x 28"	52-1/8" x 84"	■	■	■	■	+65/-70	■			■	■
				54" x 84"			+70/-110	■						
	O/X Custom Sash	3-1/2"	16-1/4" x 26"	52-1/8" x 91-13/16"	■	■	■	■	+65/-70	■			■	■
				54" x 91-3/4"			+70/-110	■						
Double Hung (DH5560)	X/X Equal	3-1/2"	16-1/4" x 26-1/2" or 17-1/2" x 24"	52-1/8" x 84"	■	■	■	■	+65/-70	■			■	■
				54" x 84"			+70/-110	■						
	X/X Proview	3-1/2"	16-1/2" x 29"	52-1/8" x 75"	■	■	■	■	+65/-70	■			■	■
				54" x 84"			+70/-110	■						
	X/X Custom Sash	3-1/2"	16-1/4" x 32"	52-1/8" x 86-3/8"	■	■	■	■	+65/-70	■			■	■
				54" x 84"			+70/-110	■						
Horizontal Roller (HR5510)	XO / OX Equal	3-1/2"	25-1/2" x 20-1/4" or 33-3/4" x 16-1/4"	75" x 63"	■	■	■	■	+65/-70	■	+65/-70	■	■	■
				75" x 72"					+50/-50	■				
				75" x 76"							+65/-80 +65/-110*	■		
	XOX 1/4-1/2-1/4	3-1/2"	45-1/8" x 17" or 47-3/4" x 16-1/4"	120" x 63"	■	■	■	■	+65/-70	■	+65/-110	■	■	■
	XOX 1/3-1/3-1/3	3-1/2"	35-1/4" x 17-1/4" or 38" x 16-1/4"	92" x 63"	■	■	■	■	+65/-70	■			■	■
				120" x 63"							+65/-110	■		
XOX Custom Sash	3-1/2"	35-1/4" x 17-1/4" or 38" x 16-1/4"	140" x 63"	■	■	■	■			+65/-110	■	■	■	
Casement (CA5540)	X Standard Hinge	3-1/2"	17" x 20"	36" x 71-9/16" or 34-5/16" x 75"	■	■	■	■	+50/-50	■	+65/-66.5 +65/-70*	■	■	■
				36" x 84"					+65/-70	■			■	■
Awning (AW5540)	X	3-1/2"	21-1/4" x 19-5/8"	60" x 42"	■	■	■	■	+50/-50	■	+70/-110	■	■	■
				52-1/8" x 42"					+65/-70	■	+70/-110	■		
				36" x 84"							+70/-110	■		

* Maximum design pressure on smaller sizes.

**Maximum negative design pressure is 70 on Integral Nail Fin and J-Channel window frame types.

Product Styles and Sizes					Frame Styles				Test Methods and Certifications				
Product Style	Configuration	Nominal Frame Depth	Minimum Size (actual DLO frame size)	Maximum Size (actual DLO frame size)	5/8" Flange	Integral Nail Fin**	J-Channel**	Equal Leg	AAMA A440 & ASTM E1886/1996		TAS 201 / 202 / 203		Florida Product Approval ENERGY STAR®
									Design Pressure	Keystone Certification	Design Pressure	Miami-Dade NOA	
Picture Window / Architectural + (PW/AR5520)	O	3-1/2"	10" x 16"	75" x 48"	■	■	■	■	+50/-50	■	+70/-70 (Fin) +80/-110	■	■
				96" x 63" or 84" x 72"					+70/-70	■			
				Up to 42 sq. ft.									
	O	3-1/2"	12-1/2" x 18"	75" x 48"	■	■	■	■	+50/-50	■	+70/-70 (Fin) +80/-110	■	■
				96" x 63" or 84" x 72"					+70/-70	■			
				Up to 42 sq. ft.									
Sliding Glass Door (SGD5570)	By-Pass or Pocket and 90° or 135° Corners	2-track 5-7/8" 3-track 8-1/4" 4-track 10-5/8"	22-15/16" x 27-3/4" panel	4'0" x 8'0" panel	■	■	■	■	+100/-100	■	+100/-100	■	■
				5'0" x 8'0" panel					+80/-80	■	+80/-80	■	■
				4'0" x 10'0" panel					+60/-65	■	+60/-65	■	■
				5'0" x 10'0" panel					+45/-50	■	+49.6/-53.7	■	■
French Door (FD5555)	X	4-9/16"	20" x 74"	38-3/4" x 96"			■	+70/-70	■	+70/-70	■	■	
	XX	4-9/16"	36" x 74"	76" x 96"			■	+70/-70	■	+70/-70	■	■	
	O	4-9/16"	12" x 20" or 20" x 12"	40" x 111" or 111" x 40"			■	+70/-70	■	+70/-70	■	■	

+ Minimum/Maximum sizes may vary by shape. Refer to ClearQuote for specific shape sizes.

** Maximum negative design pressure is 70 on Integral Nail Fin and J-Channel window frame types.

ENERGYVUE® VINYL PRODUCT QUICK REFERENCE GUIDE

Product Styles and Sizes					Frame Styles				Test Methods and Certifications					
Product Style	Configuration	Nominal Frame Depth	Minimum Size (actual DLO frame size)	Maximum Size (actual DLO frame size)	5/8" Flange	Integral Nail Fin	J-Channel	Equal Leg	AAMA A440		TAS 202			
									Design Pressure	Keystone Certification	Design Pressure	Miami-Dade NOA	Florida Product Approval	ENERGY STAR®
Single Hung (SH5400)	O/X Equal	3-1/2"	16-1/4" x 25-1/4"	52-1/8" x 84"	■	■	■	■	+65/-70	■	+65/-70 +65/-130*	■	■	■
	O/X Proview	3-1/2"	16-1/4" x 28"	52-1/8" x 84"	■	■	■	■	+65/-70	■	+65/-70 +65/-130*	■	■	■
	O/X Custom Sash	3-1/2"	16-1/4" x 26"	52-1/8" x 91-3/4"	■	■	■	■	+65/-70	■	+65/-70 +65/-130*	■	■	■
Double Hung (DH5460)	X/X Equal	3-1/2"	16-1/4" x 26-1/2" or 17-1/2" x 24"	52-1/8" x 84"	■	■	■	■	+65/-70	■	+65/-70 +65/-130*	■	■	■
	X/X Proview	3-1/2"	16-1/4" x 29"	52-1/8" x 75"	■	■	■	■	+65/-70	■	+65/-70 +65/-130*	■	■	■
	X/X Custom Sash	3-1/2"	16-1/4" x 32"	52-1/8" x 86-3/8" 52-1/8" x 86-5/16"	■	■	■	■	+65/-70	■	+65/-70 +65/-130*	■	■	■
Horizontal Roller (HR5410)	XO / OX Equal	3-1/2"	25-1/2" x 20-1/4" or 33-3/4" x 16-1/4"	75" x 72"	■	■	■	■	+65/-70	■	+65/-70 +65/-130*	■	■	■
	XOX 1/4-1/2-1/4	3-1/2"	45-1/8" x 17" or 47-3/4" x 16-1/4"	120" x 63"	■	■	■	■	+65/-70	■	+65/-70 +65/-130*	■	■	■
	XOX 1/3-1/3-1/3	3-1/2"	35-1/4" x 17-1/4" or 38" x 16-1/4"	92" x 63" 120" x 63"	■	■	■	■	+65/-70	■	+65/-70 +65/-130*	■	■	■
	XOX Custom Sash	3-1/2"	35-1/4" x 17-1/4" or 38" x 16-1/4"	140" x 63"	■	■	■	■			+65/-70 +65/-130*	■	■	■
Casement (CA5440)	X Standard Hinge	3-1/2"	17" x 20"	36" x 75"	■	■	■	■	+50/-50	■	+50/-50 +65/-114*	■	■	■
	X TrueHold Hinge	3-1/2"	17" x 20"	40" x 84"	■	■	■	■	+65/-70	■	+65/-70 +65/-130*	■	■	■
Awning (AW5440)	X	3-1/2"	21-1/4" x 19-5/8"	60" x 42"	■	■	■	■	+50/-50	■	+50/-50 +65/-130*	■	■	■
				52-1/8" x 42"					+65/-70	■	+65/-70 +65/-130*			
				30" x 84"							+65/-70 +65/-130*			

* Maximum design pressure using comparative analysis on smaller sizes.

Product Styles and Sizes					Frame Styles				Test Methods and Certifications					
Product Style	Configuration	Nominal Frame Depth	Minimum Size (actual DLO frame size)	Maximum Size (actual DLO frame size)	5/8" Flange	Integral Nail Fin	J-Channel	Equal Leg	AAMA A440		TAS 202			
									Design Pressure	Keystone Certification	Design Pressure	Miami-Dade NOA	Florida Product Approval	ENERGY STAR®
Picture Window / Architectural + (PW/AR5420)	O	3-1/2"	10" x 16"	96" x 63"					+50/-50	■				
				120" x 60"	■	■	■	■	+70/-70	■			■	■
				Up to 50 sq. ft.							+70/-70 +80/-98.2*	■		
	O	3-1/2"	12-1/2" x 18"	96" x 63"					+50/-50	■				
				120" x 60"	■	■	■	■	+70/-70	■			■	■
				Up to 50 sq. ft.							+70/-70 +80/-98.2*	■		
Sliding Glass Door (SGD5470)	By-Pass or Pocket and 90° or 135° Corners	2-track 5-7/8"	22-15/16" x 27-3/4" panel	4'0" x 8'0" panel		■		■	+80/-80	■	+80/-80 +169.4/-169.4*	■	■	■
		3-track 8-1/4"		5'0" x 8'0" panel		■		■	+60/-60	■	+60/-60 +74.1/-74.1*	■	■	■
		4-track 10-5/8"		4'0" x 10'0" panel		■		■	+60/-65	■	+60/-65 +120/-130*	■	■	■
French Door (FD5455)	X	4-9/16"	20" x 74"	38-3/4" x 96"				■	+70/-70	■	+70/-70	■	■	■
	XX	4-9/16"	36" x 74"	76" x 96"				■	+70/-70	■	+70/-70	■	■	■
	O	4-9/16"	12" x 20" or 20" x 12"	40" x 111" or 111" x 40"				■	+70/-70	■	+70/-70	■	■	■

+ Minimum/Maximum sizes may vary by shape. Refer to ClearQuote for specific shape sizes.

* Maximum design pressure using comparative analysis on smaller sizes.

Single Hung

(SH5400 & SH5500)

FEATURES:

- Nominal 3-1/2" frame depth
- 5/8" double wall front flange
- Removable tilt sash design
- Constant Force or spiral balance system
- SecureConnect sash corner technology
- ComfortLift™ sash handles
- Stainless steel assembly screws
- Roll-formed half screen with 1816 charcoal mesh

OPTIONS:

- Commodity, Modular, Nominal and custom sizes
- Integral nail fin, J-Channel and Equal leg frame
- EnergyShield™ & EnergyShield™ Max Low-E
- Argon gas
- Standard or Pro-view (Oriol) sash styles
- Radius Top and Half Radius Top
- Arch Top and Half Arch Top
- Bottom sash locks
- Vent latches
- Window Opening Control Device (WOOD)
- Extruded screen frame

PERFORMANCE:

WinGuard® Vinyl

- Sizes up to 54" x 91-3/4"
- Design Pressures up to +70/-110

EnergyVue® Vinyl

- Sizes up to 52-1/8" x 91-3/4"
- Design Pressures up to +65/-130

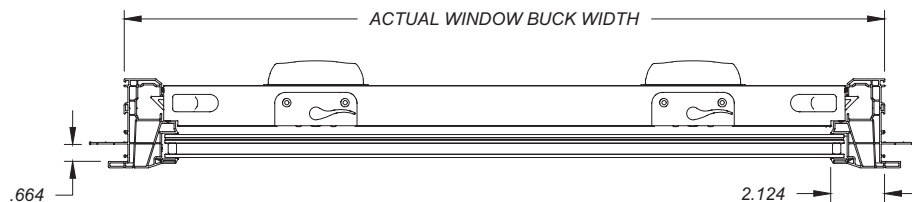
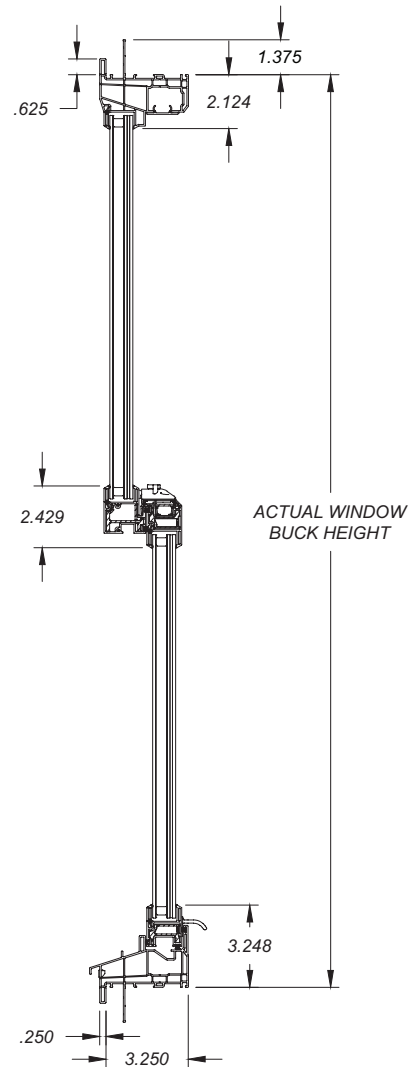

WinGuard® Vinyl glazing shown.

COMMODITY SIZES

Height	Width				
	18-1/8"	25-1/2"	36"	52-1/8"	54"
25"	12	H32	22	32	T12
37-3/8"	13	H33	23	33	T13
49-5/8"	14	H34	24	34	T14
62"	15	H35	25	35	T15
75"	16	H36	26	36	T16
84"	17	H17	27	37	T17
91-3/4"	17H	H37H	27H	37H	T17H

Egress is 5.0 SF or greater

Egress is 5.7 SF or greater

MODULAR SIZES

Height	Width				
	23"	31"	39"	43"	47"
25"	2022	2822	3422	3822	4022
37-3/8"	2033	2833	3433	3833	4033
49-5/8"	2043	2843	3443	3843	4043
62"	2053	2853	3453	3853	4053
75"	2064	2864	3464	3864	4064

NOMINAL SIZES

Height	Width								
	19-1/2"	23-1/2"	27-1/2"	29-1/2"	31-1/2"	35-1/2"	39-1/2"	43-1/2"	47-1/2"
35-1/2"	1830	2030	2430	2630	2830	3030	3430	3830	4030
37-1/2"	1832	2032	2432	2632	2832	3032	3432	3832	4032
43-1/2"	1838	2038	2438	2638	2838	3038	3438	3838	4038
45-1/2"	18310	20310	24310	26310	28310	30310	34310	38310	40310
47-1/2"	1840	2040	2440	2640	2840	3040	3440	3840	4040
49-1/2"	1842	2042	2442	2642	2842	3042	3442	3842	4042
51-1/2"	1844	2044	2444	2644	2844	3044	3444	3844	4044
53-1/2"	1846	2046	2446	2646	2846	3046	3446	3846	4046
59-1/2"	1850	2050	2450	2650	2850	3050	3450	3850	4050
61-1/2"	1852	2052	2452	2652	2852	3052	3452	3852	4052
65-1/2"	1856	2056	2456	2656	2856	3056	3456	3856	4056
71-1/2"	1860	2060	2460	2660	2860	3060	3460	3860	4060
73-1/2"	1862	2062	2462	2662	2862	3062	3462	3862	4062

Note: Egress calculations are based on standard glass package, constant force balance, comfort lift handles, minimum reinforcement as required/certified for size, and no grids or other options that would change the outcome of egress. Calculate additional sizes and configurations using formula or ClearQuote.

Single Hung

(SH5400 & SH5500)

EGRESS FORMULA

Equal Sash	All Frame Types
Clear Opening Width	Actual window width - 4.250"
Clear Opening Height (Constant force balance)	(Actual window height * .500) - 4.591"
Clear Opening Height (Spiral balance)	(Actual window height * .500) - 8.341"

Egress Formulas are based on standard window features. Material or design changes may be made without notice or liability. In the event of discrepancies, only those egress opening sizes displayed in ClearQuote will be honored.

STANDARD LITES FOR COLONIAL GRIDS

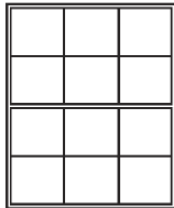

Equal Sash Configuration		
Window Width	Up to 30.9"	= 2 lites across (1V) per lite of glass
Window Width	31" - 41.9"	= 3 lites across (2V) per lite of glass
Window Width	42" - 54"	= 4 lites across (3V) per lite of glass
Window Height	Up to 30.9"	= 1 lite down (0H) per lite of glass
Window Height	31" - 75.9"	= 2 lites down (1H) per lite of glass
Window Height	76" - 84"	= 3 lites down (2H) per lite of glass

STANDARD LITES FOR COLONIAL GRIDS

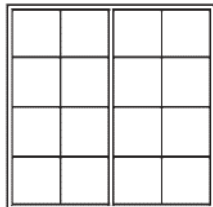

Proview Sash Configuration		
Window Width	Up to 30.9"	= 2 lites across (1V) per lite of glass
Window Width	31" - 41.9"	= 3 lites across (2V) per lite of glass
Window Width	42" - 54"	= 4 lites across (3V) per lite of glass
Window Height	Up to 30.9"	Vent = 1 lites down (0H) per lite of glass Fixed = 2 lites down (1H) per lite of glass
Window Height	31" - 75.9"	Vent = 2 lites down (1H) per lite of glass Fixed = 3 lites down (2H) per lite of glass
Window Height	76" - 91.75"	Vent = 3 lites down (2H) per lite of glass Fixed = 4 lites down (2H) per lite of glass

Double Hung

(DH5460 & DH5560)

FEATURES:

- Nominal 3-1/2" frame depth
- 5/8" double wall front flange
- Removable tilt sash design
- Constant Force or spiral balance system
- SecureConnect sash corner technology
- ComfortLift™ sash handles
- Stainless steel assembly screws
- Extruded full screen with 1816 charcoal mesh

OPTIONS:

- Commodity, Modular, Nominal and custom sizes
- Integral nail fin, J-Channel and Equal leg frame
- EnergyShield™ & EnergyShield™ Max Low-E
- Argon gas
- Standard or Pro-view (Oriel) sash styles
- Radius Top and Half Radius Top
- Arch Top and Half Arch Top
- Bottom sash locks
- Vent latches
- Window Opening Control Device (WOCD)

PERFORMANCE:

WinGuard® Vinyl

- Sizes up to 54" x 84" or 52-1/8" x 86-5/16"
- Design Pressures up to +70/-110

EnergyVue® Vinyl

- Sizes up to 52-1/8" x 86-5/16"
- Design Pressures up to +70/-110 or +65/-130

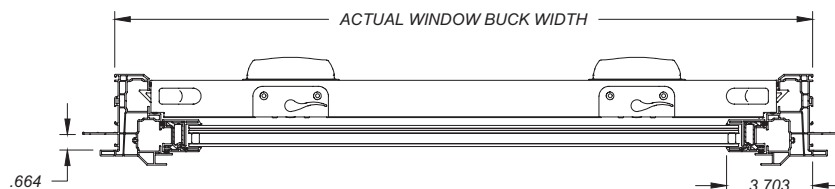
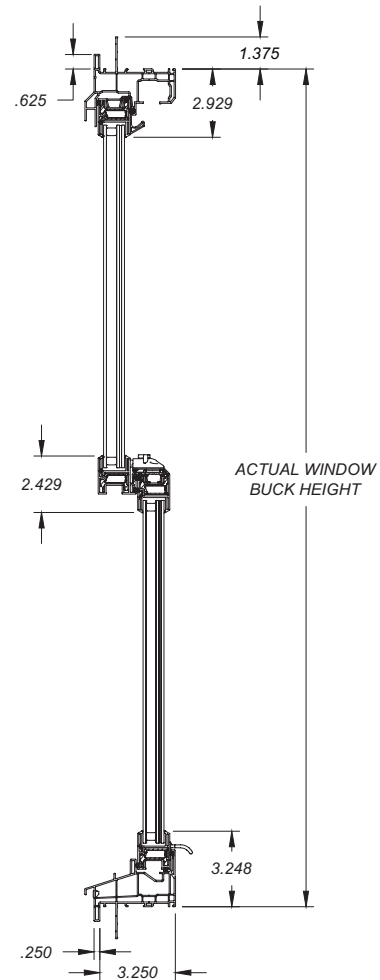

WinGuard® Vinyl glazing shown.

Double Hung

(DH5460 & DH5560)

COMMODITY SIZES

Height	Width				
	18-1/8"	25-1/2"	36"	52-1/8"	54"
25"	12	H32	22	32	T12
37-3/8"	13	H33	23	33	T13
49-5/8"	14	H34	24	34	T14
62"	15	H35	25	35	T15
75"	16	H36	26	36	T16
84"	17	H37	27	37	T17

Egress is 5.0 SF or greater

Egress is 5.7 SF or greater

MODULAR SIZES

Height	Width				
	23"	31"	39"	43"	47"
25"	2022	2822	3422	3822	4022
37-3/8"	2033	2833	3433	3833	4033
49-5/8"	2043	2843	3443	3843	4043
62"	2053	2853	3453	3853	4053
75"	2064	2864	3464	3864	4064

NOMINAL SIZES

Height	Width								
	19-1/2"	23-1/2"	27-1/2"	29-1/2"	31-1/2"	35-1/2"	39-1/2"	43-1/2"	47-1/2"
35-1/2"	1830	2030	2430	2630	2830	3030	3430	3830	4030
37-1/2"	1832	2032	2432	2632	2832	3032	3432	3832	4032
43-1/2"	1838	2038	2438	2638	2838	3038	3438	3838	4038
45-1/2"	18310	20310	24310	26310	28310	30310	34310	38310	40310
47-1/2"	1840	2040	2440	2640	2840	3040	3440	3840	4040
49-1/2"	1842	2042	2442	2642	2842	3042	3442	3842	4042
51-1/2"	1844	2044	2444	2644	2844	3044	3444	3844	4044
53-1/2"	1846	2046	2446	2646	2846	3046	3446	3846	4046
59-1/2"	1850	2050	2450	2650	2850	3050	3450	3850	4050
61-1/2"	1852	2052	2452	2652	2852	3052	3452	3852	4052
65-1/2"	1856	2056	2456	2656	2856	3056	3456	3856	4056
71-1/2"	1860	2060	2460	2660	2860	3060	3460	3860	4060
73-1/2"	1862	2062	2462	2662	2862	3062	3462	3862	4062

Note: Egress calculations are based on standard glass package, constant force balance, top sash continuous pull rail, bottom sash with comfort lift handles, minimum reinforcement as required/certified for size, and no grids or other options that would change the outcome of egress. Calculate additional sizes and configurations using formula or ClearQuote.

EGRESS FORMULA

Equal Sash	All Frame Types
Clear Opening Width	Actual window width - 4.250"
Clear Opening Height (Max DP50)	
Constant Force balance with Top Sash Continuous Pull Rail	(Actual window height * .500) - 4.970"
Clear Opening Height (Greater than DP50)	
Constant Force balance - 1 spring	(Actual window height * .500) - 7.970"
Constant Force balance - 2 spring	(Actual window height * .500) - 9.345"
Constant Force balance - 3 spring	(Actual window height * .500) - 10.970"
Spiral balance	(Actual window height * .500) - 7.970"
Spiral balance - special egress height	(Actual window height * .500) - 6.470"

The number of springs are determined by sash weight; sash weight varies according to glass thickness, colonial and size. Egress Formulas are based on standard window features. Material or design changes may be made without notice or liability. In the event of discrepancies, only those egress opening sizes displayed in ClearQuote will be honored.

STANDARD LITES FOR COLONIAL GRIDS

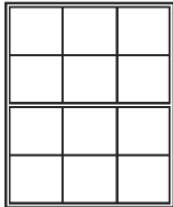

Equal Sash Configuration		
Window Width	Up to 30.9"	= 2 lites across (1V) per lite of glass
Window Width	31" - 41.9"	= 3 lites across (2V) per lite of glass
Window Width	42" - 54"	= 4 lites across (3V) per lite of glass
Window Height	Up to 30.9"	= 1 lite down (0H) per lite of glass
Window Height	31" - 75.9"	= 2 lites down (1H) per lite of glass
Window Height	76" - 84"	= 3 lites down (2H) per lite of glass

STANDARD LITES FOR COLONIAL GRIDS

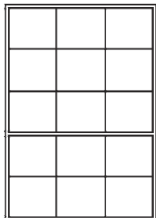

Proview Sash Configuration		
Window Width	Up to 30.9"	= 2 lites across (1V) per lite of glass
Window Width	31" - 41.9"	= 3 lites across (2V) per lite of glass
Window Width	42" - 54"	= 4 lites across (3V) per lite of glass
Window Height	Up to 30.9"	Vent = 1 lites down (0H) per lite of glass Fixed = 2 lites down (1H) per lite of glass
Window Height	31" - 75.9"	Vent = 2 lites down (1H) per lite of glass Fixed = 3 lites down (2H) per lite of glass
Window Height	76" - 86.625"	Vent = 3 lites down (2H) per lite of glass Fixed = 4 lites down (2H) per lite of glass

Horizontal Roller

(HR5410 & HR5510)

FEATURES:

- Nominal 3-1/2" frame depth
- 5/8" double wall front flange
- Removable sash design
- Nylon ball bearing wheels
- SecureConnect™ sash corner technology
- Stainless steel assembly screws
- Roll-formed half screen with 1816 charcoal mesh

OPTIONS:

- Commodity, Modular, Nominal and custom sizes
- Integral nail fin, J-Channel and Equal leg frame
- EnergyShield™ & EnergyShield™ Max Low-E
- Argon gas
- 2-Lite (XO or OX) or 3-Lite (XOX) configuration
- Concealed egress lock
- Vent latches
- Window Opening Control Device (WOOD)
- Extruded screen frame

PERFORMANCE:

WinGuard® Vinyl

- 2-Lite configurations up to 75" x 76"
- 3-Lite configurations up to 140" x 63"
- Design Pressures up to +70/-110

EnergyVue® Vinyl

- 2-Lite configurations up to 75" x 72"
- 3-Lite configurations up to 140" x 63"
- Design Pressures up to +65/-130

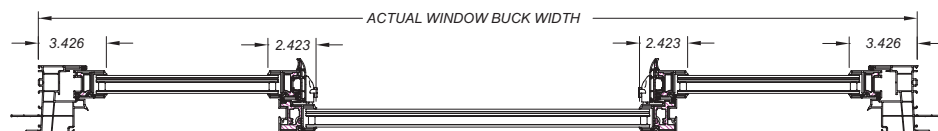
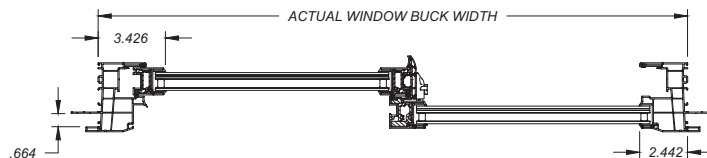
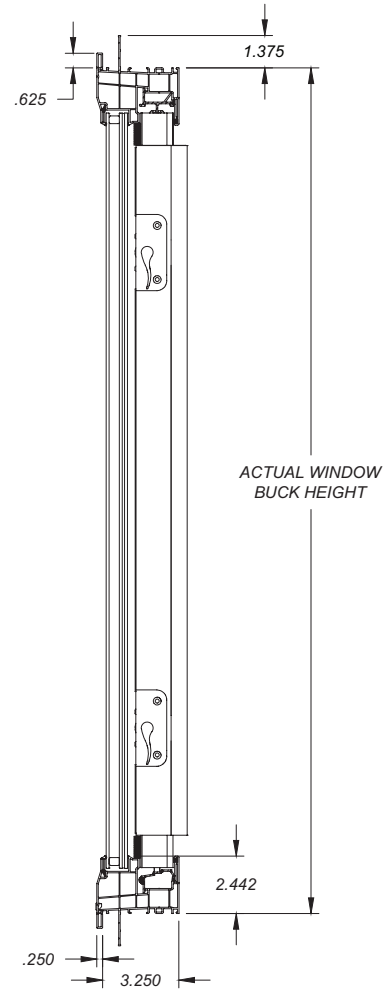

WinGuard® Vinyl glazing shown.

XO/OX COMMODITY SIZES

Height	Width		
	25-1/2"	36"	52-1/8"
25"	H32	22	32
37-3/8"	H33	23	33
49-5/8"	H34	24	34
62"	H35	25	35

XOX1/4-1/2-1/4 COMMODITY SIZES

Height	Width			
	52-1/8"	73"	105-3/8"	110"
25"	32	D22	D32	T22
37-3/8"	33	D23	D33	T23
49-5/8"	34	D24	D34	T24
62"	35	D25	D35	T25

Egress is 5.0 SF or greater
Egress is 5.7 SF or greater

XO/OX MODULAR SIZES

Height	Width							
	35"	47"	53"	59"	65"	71"	73"	75"
25"	3022	4022	4622	5022	5622	6022	6222	6422
37-3/8"	3033	4033	4633	5033	5633	6033	6233	6433
49-5/8"	3043	4043	4643	5043	5643	6043	6243	6443
54"	3047	4047	4647	5047	5647	6047	6247	6447
63"	3054	4054	4654	5054	5654	6054	6254	6454
72"	3061	4061	4661	5061	5661	6061	6261	6461
76"	3065	4065	4665	5065	5665	6065	6265	6465

XOX1/4-1/2-1/4 MODULAR SIZES

Height	Width									
	47"	59"	71"	83"	92"	95"	107"	120"	131"	140"
25"	4022	5022	6022	7022	7922	8022	9022	10122	11022	11922
37-3/8"	4033	5033	6033	7033	7933	8033	9033	10133	11033	11933
49-5/8"	4043	5043	6043	7043	7943	8043	9043	10143	11043	11943
54"	4047	5047	6047	7047	7947	8047	9047	10147	11047	11947
63"	4054	5054	6054	7054	7954	8054	9054	10154	11054	11954

XO/OX NOMINAL SIZES

Height	Width			
	35-1/2"	47-1/2"	59-1/2"	71-1/2"
23-1/2"	3020	4020	5020	6020
35-1/2"	3030	4030	5030	6030
47-1/2"	3040	4040	5040	6040
59-1/2"	3050	4050	5050	6050

XOX1/4-1/2-1/4 NOMINAL SIZES

Height	Width				
	71-1/2"	83-1/2"	95-1/2"	107-1/2"	110-1/2"
23-1/2"	6020	7020	8020	9020	9320
35-1/2"	6030	7030	8030	9030	9330
47-1/2"	6040	7040	8040	9040	9340
53-1/2"	6046	7046	8046	9046	9346

Note: Egress calculations are based on standard glass package, minimum reinforcement as required/certified for size, and no grids or other options that would change the outcome of egress. Calculate additional sizes and configurations using formula or ClearQuote.

Horizontal Roller

(HR5410 & HR5510)

EGRESS FORMULA

2-Lite X.O.O.X	Flange Frame
Clear Opening Width	(Actual window width / 2) - 4.976"
Clear Opening Height	Actual window height - 4.937"
3-Lite XOX 1/4-1/2-1/4	Flange Frame
Clear Opening Width	(Actual window width / 4) - 1.688"
Clear Opening Height	Actual window height - 4.937"
3-Lite XOX 1/3-1/3-1/3	Flange Frame
Clear Opening Width	(Actual window width / 3) - 4.708"
Clear Opening Height	Actual window height - 4.937"

Egress Formulas are based on standard window features. Material or design changes may be made without notice or liability. In the event of discrepancies, only those egress opening sizes displayed in ClearQuote will be honored.

STANDARD LITES FOR COLONIAL GRIDS

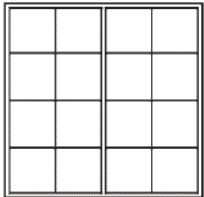

2-Lite Configuration		
Window Width	Up to 58.9"	= 1 lites across (0V) per lite of glass
Window Width	59" - 70.9"	= 2 lites across (1V) per lite of glass
Window Width	71" - 75"	= 3 lites across (2V) per lite of glass
Window Height	Up to 30.9"	= 2 lites down (1H) per lite of glass
Window Height	31" - 41.9"	= 3 lites down (2H) per lite of glass
Window Height	42" - 62.9"	= 4 lites down (3H) per lite of glass
Window Height	63" - 76"	= 5 lites down (4H) per lite of glass

STANDARD LITES FOR COLONIAL GRIDS

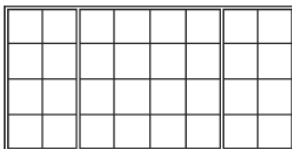

3-Lite Configuration 1/4-1/2-1/4		
Window Width	Up to 73.9"	= Vents - 1 lite across (0V) per lite of glass
		= Fixed - 2 lites across (1V) per lite of glass
Window Width	74" - 140"	= Vents - 2 lites across (1V) per lite of glass
		= Fixed - 3 lites across (2V) per lite of glass
Window Height	Up to 30.9"	= 2 lites down (1H) per lite of glass
Window Height	31" - 41.9"	= 3 lites down (2H) per lite of glass
Window Height	42" - 63"	= 4 lites down (3H) per lite of glass

Casement

(CA5440 & CA5540)

FEATURES:

- Nominal 3-1/2" frame depth
- 5/8" double wall front flange
- Hinge left or hinge right
- Standard or TrueHold™ hinge
- Operator with nesting handle
- Stainless steel assembly screws
- Extruded full screen with 1816 charcoal mesh

OPTIONS:

- Commodity, Modular, Nominal and custom sizes
- Integral nail fin, J-Channel and Equal leg frame
- EnergyShield™ & EnergyShield™ Max Low-E
- Argon gas
- Stainless Steel hardware package
- Egress hinge
- Window Opening Control Device (WOCD)

PERFORMANCE:

WinGuard® Vinyl

- Sizes up to 40" x 84"
- Design pressures up to +70/-110

EnergyVue® Vinyl

- Sizes up to 40" x 84"
- Design pressures up to +65/-130

COMPANION PRODUCTS:

AW5440/5540, PW5440/5540, AR5440/5540

Modular design with matching Awning,
Fixed Lite Picture Window and Architectural
for multiple configurations including X, XX, XOX, O

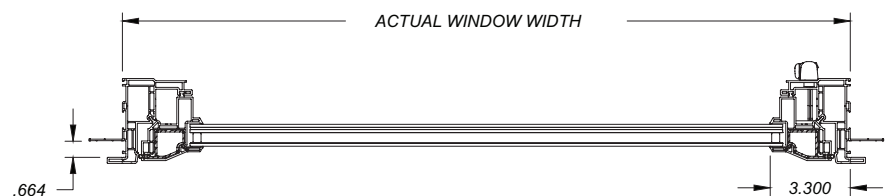
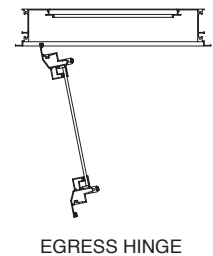
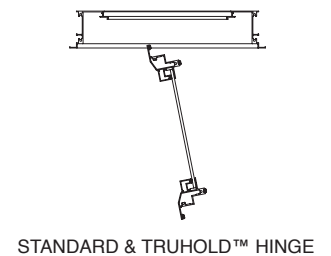
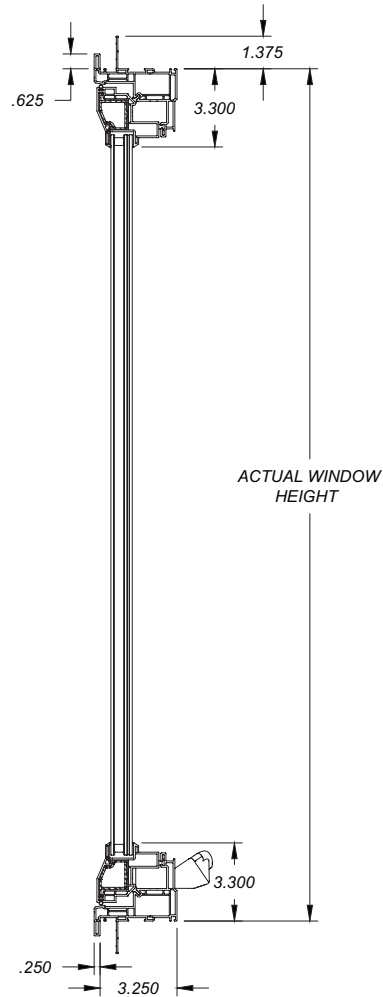

Casement

(CA5440 & CA5540)

COMMODITY SIZES

WASHABLE HINGE	Width		
	18-1/8"	25-1/2"	36"
Height			
25"	12	H32	22
37-3/8"	13	H33	23
49-5/8"	14	H34	24
62"	15	H35	25
75"	16	H36	26
84"	17	H37	27

COMMODITY SIZES

EGRESS HINGE	Width		
	18-1/8"	25-1/2"	36"
Height			
25"	-	H32	22
37-3/8"	-	H33	23
49-5/8"	-	H34	24
62"	-	H35	25
75"	-	H36	26
84"	-	H37	27

Egress is 5.0 SF or greater

Egress is 5.7 SF or greater

MODULAR SIZES

WASHABLE HINGE	Width				
	23"	27"	31"	34"	40"
Height					
25"	2022	2422	2822	21122	3522
37-3/8"	2033	2433	2833	21133	3533
49-5/8"	2043	2443	2843	21143	3543
54"	2046	2446	2846	21146	3546
62"	2053	2453	2853	21153	3553
75"	2064	2464	2864	21164	3564
84"	2071	2471	2871	21171	3571

MODULAR SIZES

EGRESS HINGE	Width				
	23"	27"	31"	34"	40"
Height					
25"	-	2422	2822	21122	3522
37-3/8"	-	2433	2833	21133	3533
49-5/8"	-	2443	2843	21143	3543
54"	-	2446	2846	21146	3546
62"	-	2453	2853	21153	3553
75"	-	2464	2864	21164	3564
84"	-	2471	2871	21171	3571

NOMINAL SIZES

WASHABLE HINGE	Width				
	19-1/2"	23-1/2"	27-1/2"	29-1/2"	35-1/2"
Height					
23-1/2"	1820	2020	2420	2620	3020
31-1/2"	1828	2028	2428	2628	3028
35-1/2"	1830	2030	2430	2630	3030
39-1/2"	1834	2034	2434	2634	3034
47-1/2"	1840	2040	2440	2640	3040
59-1/2"	1850	2050	2450	2650	3050
71-1/2"	1860	2060	2460	2660	3060
73-1/2"	1862	2062	2462	2662	3062

NOMINAL SIZES

EGRESS HINGE	Width				
	19-1/2"	23-1/2"	27-1/2"	29-1/2"	35-1/2"
Height					
23-1/2"	-	-	2420	2620	3020
31-1/2"	-	-	2428	2628	3028
35-1/2"	-	-	2430	2630	3030
39-1/2"	-	-	2434	2634	3034
47-1/2"	-	-	2440	2640	3040
59-1/2"	-	-	2450	2650	3050
71-1/2"	-	-	2460	2660	3060
73-1/2"	-	-	2462	2662	3062

Note: Egress calculations are based on standard glass package, minimum reinforcement as required/certified for size, and no grids or other options that would change the outcome of egress. Calculate additional sizes and configurations using formula or ClearQuote.

EGRESS FORMULA

	Standard Washable Hinge	TrueHold Hinge	Egress Hinge
Clear Opening Width	Actual window width - 11.813"	Actual window width - 12.187"	Actual window width - 7.500"
Clear Opening Height	Actual window height - 5.75"	Actual window height - 5.75"	Actual window height - 5.75"

Egress Formulas are based on standard window features. Material or design changes may be made without notice or liability. In the event of discrepancies, only those egress opening sizes displayed in ClearQuote will be honored.

STANDARD LITES FOR COLONIAL GRIDS



Casement X Configuration		
Window Width	Up to 29.9"	= 1 lites across (0V) per lite of glass
Window Width	30" - 40"	= 2 lites across (1V) per lite of glass
Window Height	Up to 28.9"	= 2 lites down (1H) per lite of glass
Window Height	29" - 38.9"	= 3 lites down (2H) per lite of glass
Window Height	39" - 49.9"	= 4 lites down (3H) per lite of glass
Window Height	50" - 63.9"	= 5 lites down (4H) per lite of glass
Window Height	64" - 75.9"	= 6 lites down (5H) per lite of glass
Window Height	76" - 84"	= 7 lites down (6H) per lite of glass

Awning

(AW5440 & AW5540)

FEATURES:

- Nominal 3-1/2" frame depth
- 5/8" double wall front flange
- Operator with nesting handle
- Stainless steel assembly screws
- Extruded full screen with 1816 charcoal mesh

OPTIONS:

- Commodity, Modular, Nominal and custom sizes
- Integral nail fin, J-Channel and Equal leg frame
- EnergyShield™ & EnergyShield™ Max Low-E
- Argon gas
- Stainless Steel hardware package

PERFORMANCE:

WinGuard® Vinyl

- Sizes up to 60" x 42" or 36" x 84"
- Design pressures up to +70/-110

EnergyVue® Vinyl

- Sizes up to 60" x 42" or 30" x 84"
- Design pressures up to +65/-70

COMPANION PRODUCTS:

CA5440/5540, PW5440/5540, AR5440/5540

Modular design with matching Casement, Fixed Lite Picture Window and Architectural for multiple configurations including X, XX, XOX, O

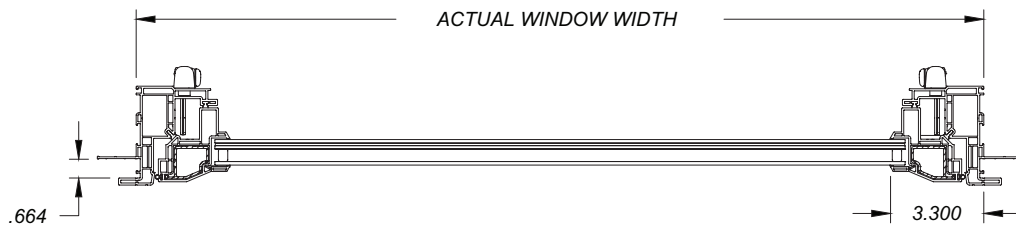
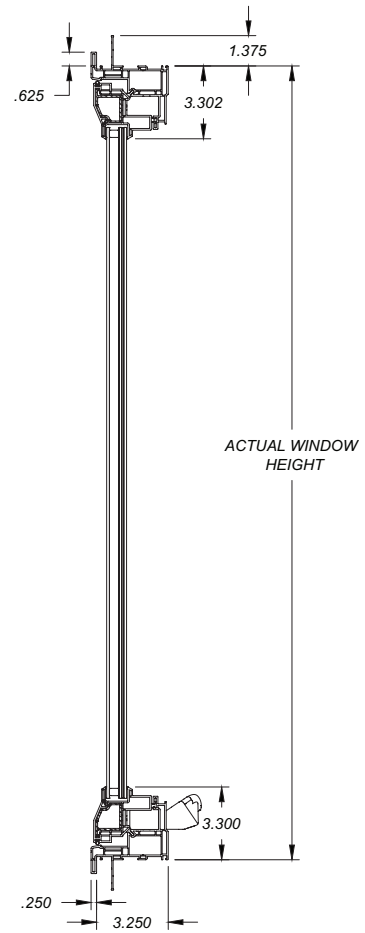

WinGuard® Vinyl glazing shown.

COMMODITY SIZES

Height	Width		
	25-1/2"	36"	52-1/8"
25"	H32	22	32
37-3/8"	H33	23	33
49-5/8"	H34	24	-
62"	H35	25	-
75"	H36	26	-
84"	H37	27	-

MODULAR SIZES

Height	Width						
	23"	27"	30"	34"	40"	47"	60"
25"	2022	2422	2722	21122	3522	4022	5122
37-3/8"	2033	2433	2733	21133	3533	4033	5133
42"	2037	2437	2737	21137	3537	4037	5137
49-5/8"	2043	2443	2743	21143	3543	-	-
54"	2046	2446	2746	21146	3546	-	-
62"	2053	2453	2753	21153	3553	-	-
75"	2064	2464	2764	21164	3564	-	-
84"	2071	2471	2771	21171	-	-	-

NOMINAL SIZES

Height	Width				
	19-1/2"	23-1/2"	27-1/2"	29-1/2"	35-1/2"
23-1/2"	1820	2020	2420	2620	3020
31-1/2"	1828	2028	2428	2628	3028
35-1/2"	1830	2030	2430	2630	3030
39-1/2"	1834	2034	2434	2634	3034

Note: Awning windows do not meet egress.

Awning

(AW5440 & AW5540)

STANDARD LITES FOR COLONIAL GRIDS



Projected Awning Configuration		
Window Width	Up to 24.9"	= 2 lites across (1V) per lite of glass
Window Width	25" - 39.9"	= 3 lites across (2V) per lite of glass
Window Width	40" - 60"	= 4 lites across (1V) per lite of glass
Window Height	Up to 28.9"	= 2 lites down (1H) per lite of glass
Window Height	29" - 38.9"	= 3 lites down (2H) per lite of glass
Window Height	29" - 38.9"	= 4 lites down (3H) per lite of glass
Window Height	39" - 49.9"	= 5 lites down (4H) per lite of glass
Window Height	50" - 63.9"	= 6 lites down (5H) per lite of glass
Window Height	64" - 84"	= 7 lites down (6H) per lite of glass

Fixed Lite Picture Window & Architecturals

(PW & AR5420/5520, PW & AR5440/5540)

FEATURES:

- Nominal 3-1/2" frame depth
- 5/8" double wall front flange
- Standard style picture window
- Various architectural shapes

OPTIONS:

- Custom sizes
- Integral nail fin, J-Channel and Equal leg frame
- EnergyShield™ & EnergyShield™ Max Low-E
- Argon gas

PERFORMANCE:

WinGuard® Vinyl

- Sizes up to 42 sq. ft.
- Design Pressures up to +80/-110

EnergyVue® Vinyl

- Sizes up to 50 sq. ft.
- Design pressures up to +80/-98.2

COMPANION PRODUCTS:

CA5440/5540, AW5440/5540

PW & AR 5440/5540 features a modular design with matching Casement and Awning Window for multiple configurations including X, XX, XO, O



HALF CIRCLE

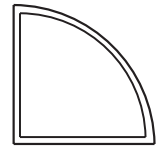

QUARTER CIRCLE



EYEBROW



ARCH

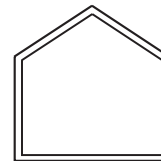

PEAK PENTAGON

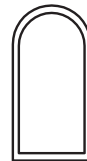

OVAL

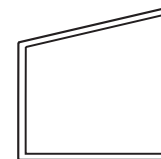

TRAPEZOID

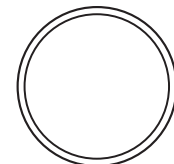

FULL CIRCLE

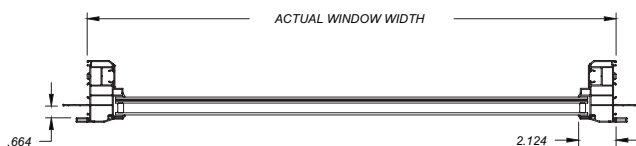

STANDARD PICTURE WINDOW & ARCHITECTURAL
(PW & AR5420/5520)

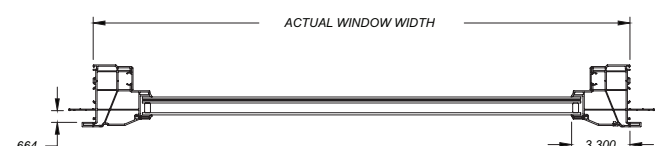

CASEMENT PICTURE WINDOW & ARCHITECTURAL
(PW & AR5440/5540)

WinGuard® Vinyl glazing shown.

Preferred Sliding Glass Door

(SGD5470 & SGD5570)

FEATURES:

- 1-1/16" laminated insulating glass
- 2, 3 or 4 tracks
- 3-1/2" clear anodize sill riser
- Multi-panel by-pass and pocket configurations
- Dual point mortise lock
- Tandem steel roller assembly

OPTIONS:

- Nominal and Custom sizes
- Configurations up to 8 panels
- 1-1/2" add on nail fin
- EnergyShield™ & EnergyShield™ Max Low-E
- Argon gas
- 90° and 135° corner door configurations
- Inside or outside corner configurations
- Counter top unit (sliding glass window)
- Tandem stainless steel or nylon roller assembly
- Stainless steel package
- Various sill risers
- Raised, Curved or Contemporary handles
- Recessed pull with lock
- Secondary lock
- Standard or box screen

PERFORMANCE:

WinGuard® Vinyl

- Panel sizes up to 5'0" x 10'0"
- Design pressures up to +100/-100

EnergyVue® Vinyl

- Panel sizes up to 4'0" x 10'0" or 5'0" x 8'0"
- Design pressures up to +169.4/-169.4

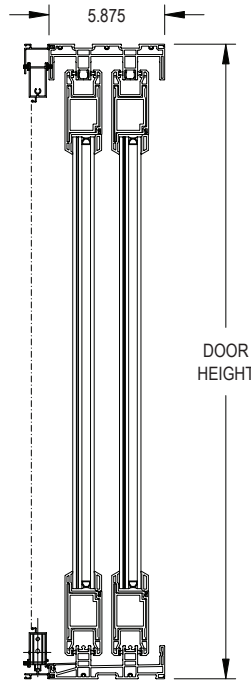

SILL RISER

NOMINAL SILL RISER HEIGHTS

Flush	1-11/16"
Standard	2-1/2"
Medium	4-1/16"
High	4-5/8"

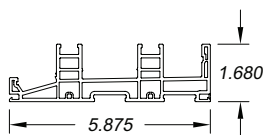
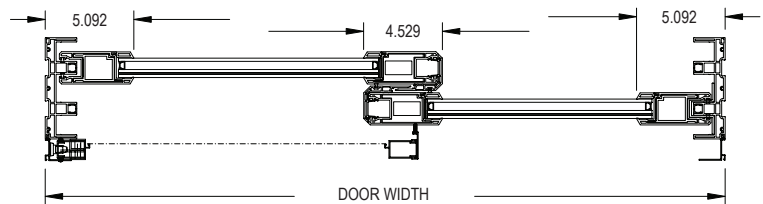

2-TRACK FRAME DEPTH

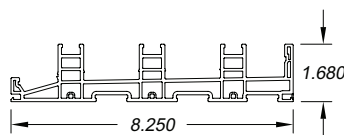

3-TRACK FRAME DEPTH

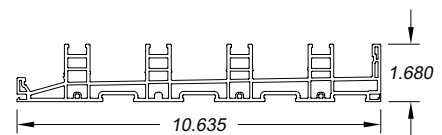

4-TRACK FRAME DEPTH

WinGuard® Vinyl glazing shown.

NOMINAL DOOR SIZES

By-Pass Configuration	Size Code	Overall Size Width x Height*
2P2T XO OX XX	4068	48 x 80
	5068	60 x 80
	6068	72 x 80
	8068	96 x 80
	10068	120 x 80
3P3T XXX XXO OXX	7668	87-3/16 x 80
	9068	105-3/16 x 80
	12068	141-3/16 x 80
	15068	177-3/16 x 80
4P2T OXXO XXXX	10068	119 x 80
	12068	143 x 80
	16068	191 x 80
	20068	239 x 80
4P4T XXXX OXXX XXXO	10068	114-3/8 x 80
	12068	138-3/8 x 80
	16068	186-3/8 x 80
	20068	234-3/8 x 80
3P2T OXO XOX	7668	91-13/16 x 80
	9068	109-13/16 x 80
	12068	145-13/16 x 80
	15068	181-13/16 x 80
5P3T XXX-XX, XX-XXX OX-XXO, OXX-XO	15068	176-3/16 x 80
	20068	236-3/16 x 80
	25068	296-3/16 x 80
6P3T OXX-XXO XXX-XXX	15068	173-3/8 x 80
	18068	209-3/8 x 80
	24068	281-3/8 x 80
	30068	353-3/8 x 80
8P4T OXXX-XXXO XXXX-XXXX	20068	227-11/16 x 80
	24068	275-11/16 x 80
	32068	371-11/16 x 80
	40068	467-11/16 x 80

* 6/8 heights shown

Pocket Configuration	Size Code	Overall Size Width x Height*
1P2T 1 POCKET	3068	33-13/16 x 80
	4068	45-13/16 x 80
	5068	57-13/16 x 80
2P2T 1 POCKET	5068	54-1/2 x 80
	6068	66-1/2 x 80
	8068	90-1/2 x 80
3P3T 1 POCKET	10068	114-1/2 x 80
	7668	82-1/8 x 80
	9068	100-1/8 x 80
4P4T 1 POCKET	12068	136-1/8 x 80
	15068	172-1/8 x 80
	10068	109-5/16 x 80
2P2T 2 POCKET	12068	133-5/16 x 80
	16068	181-5/16 x 80
	20068	229-5/16 x 80
4P2T 2 POCKET	5068	54-9/16 x 80
	6068	66-9/16 x 80
	8068	90-9/16 x 80
6P3T 2 POCKET	10068	114-9/16 x 80
	10068	108-15/16 x 80
	12068	132-15/16 x 80
8P4T 2 POCKET	16068	180-15/16 x 80
	20068	228-15/16 x 80
	15068	163-5/16 x 80
8P4T 2 POCKET	18068	199-5/16 x 80
	24068	271-5/16 x 80
	30068	343-5/16 x 80
	20068	217-5/8 x 80
8P4T 2 POCKET	24068	265-5/8 x 80
	32068	361-5/8 x 80
	40068	457-5/8 x 80

* 6/8 heights shown

STANDARD LITES FOR COLONIAL GRIDS

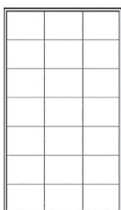

Standard Lites for Colonial Grids		
Nominal Panel Width	Up to 2'6"	=2 lites across (1V) per panel
Nominal Panel Width	3'0" & 4'0"	=3 lites across (2V) per panel
Nominal Panel Width	5'0"	=4 lites across (3V) per panel
Nominal Panel Height	6'8"	=5 lites down (4V) per panel
Nominal Panel Height	8'0"	=6 lites down (5V) per panel
Nominal Panel Height	9'0" & 10'0"	=7 lites down (6V) per panel

Preferred Sliding Glass Door

(SGD5470 & SGD5570)

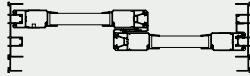
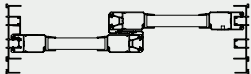
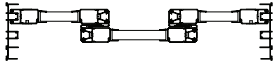
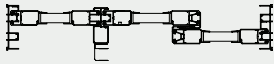
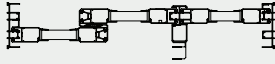
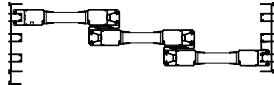
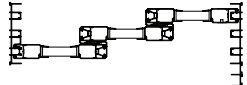
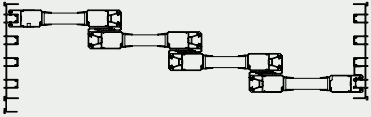
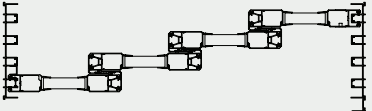
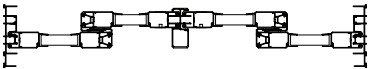
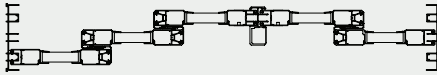
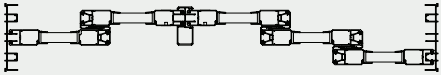
TYPE	STANDARD STACK	REVERSE STACK
2P2T XX / XO / OX		
3P2T XOX		SAME AS STANDARD STACK
3P2T OXO		
3P3T XXX / XXO / OXX		
4P4T XXXX / XXXO / OXXX		
4P2T XXXX / OXXO		SAME AS STANDARD STACK
5P3T OXX-XO / OX-XXO XXX-XX / XX-XXX		

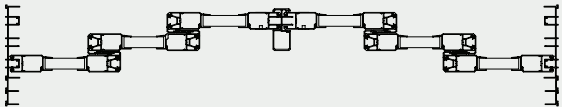
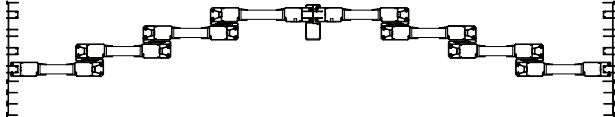
TYPE	STANDARD STACK
6P3T OXX-XXO XXX-XXX	
8P4T OXXX-XXXO XXXX-XXXX	

Preferred French Door

(FD5455 & FD5555)

FEATURES:

- 4-9/16" Cellular vinyl frame depth
- Equal leg frame
- Single or double door
- Outswing
- 1-3/4" x 5" Cellular vinyl panel stile reinforced with aluminum
- 1-3/8" clear anodized threshold with cover
- Multi-point euro groove locking system
- Handle to deadbolt bore 3-5/8" on center
- Brushed stainless steel hinges

OPTIONS:

- Nominal and Custom sizes
- 5/8" add-on front flange
- EnergyShield™ & EnergyShield™ Max Low-E
- Argon gas
- Narrow or Full Frame Sidelite and Transom

PERFORMANCE:

WinGuard® Vinyl and EnergyVue®

- Single door sizes up to 38-13/16" x 96"
- Double door sizes up to 76" x 96"
- Sidelite sizes up to 40" x 111"
- Transom sizes up to 111" x 40"
- Design pressures up to +70/-70

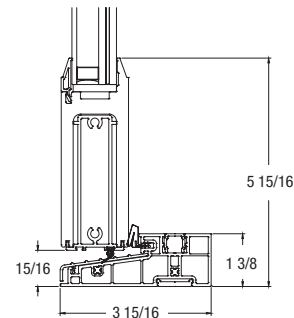
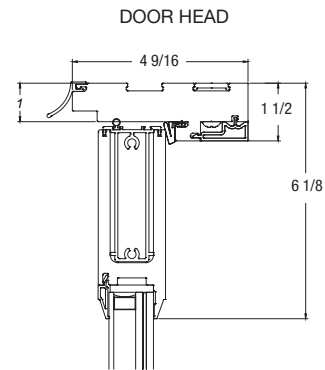

DOOR SILL

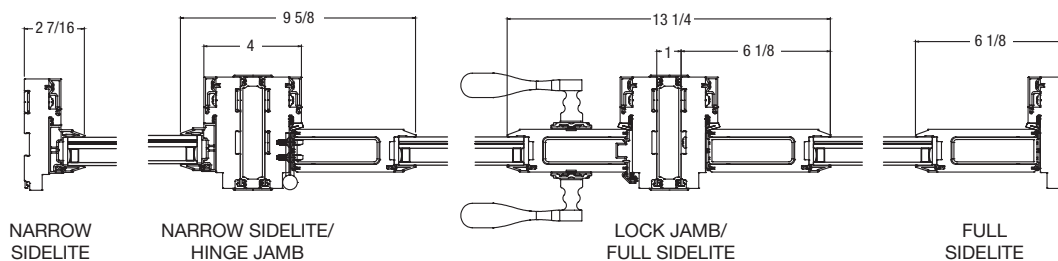
NARROW
SIDELITENARROW SIDELITE/
HINGE JAMBLOCK JAMB/
FULL SIDELITEFULL
SIDELITE

Preferred French Door

(FD5455 & FD5555)

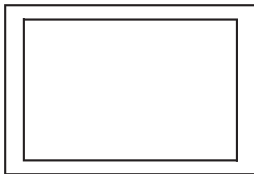

NARROW FRAME

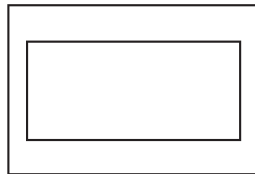

FULL HEAD/SILL (Narrow Jambs)

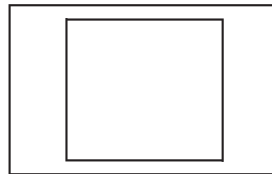

FULL JAMB (Narrow Head/Sill)

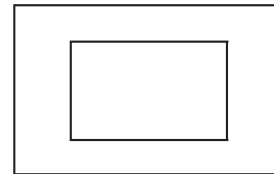

FULL FRAME

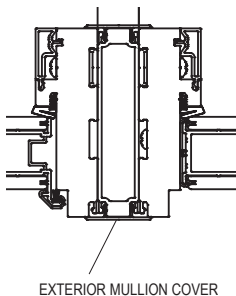

EXTERIOR MULLION COVER

1" FRENCH DOOR MULLION (VERTICAL)

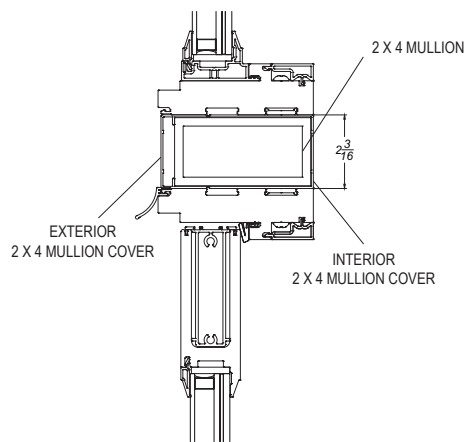

2X4 TUBE MULLION (HORIZONTAL)

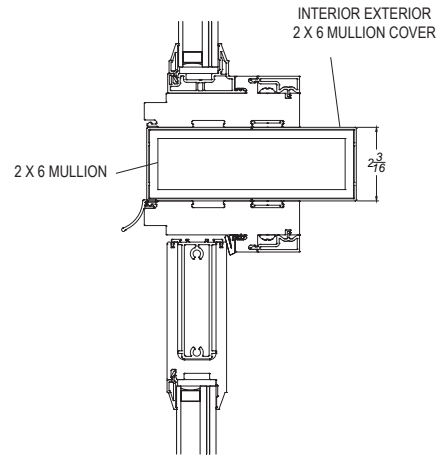

2X6 TUBE MULLION (HORIZONTAL)

NOMINAL DOOR SIZES

SINGLE DOOR	Width				
Height	25-1/2"	31-1/2"	33-1/2"	37-1/2"	38-3/4"
79-3/4"	2068	2668	2868	3068	3168
83-3/4"	2070	2670	2870	3070	3170
95-3/4"	2080	2680	2880	3080	3180

NOMINAL DOOR SIZES

DOUBLE DOOR	Width				
Height	47-3/4"	59-3/4"	63-3/4"	71-3/4"	75-3/4"
79-3/4"	4068	5068	5468	6068	6468
83-3/4"	4070	5070	5470	6070	6470
95-3/4"	4080	5080	5480	6080	6480

EGRESS FORMULA

	Single Door	Double Door
Clear Opening Width	Door Width - 4.875"	(Door Width / 2) - 3.750"
Clear Opening Height	Door Height - 3.750"	Door Height - 3.259"

Egress Formulas are based on standard window features. Material or design changes may be made without notice or liability. In the event of discrepancies, only those egress opening sizes displayed in ClearQuote will be honored.

STANDARD LITES FOR COLONIAL GRIDS



Single French Door		
Single Door Width	Up to 31.500"	=2 lites across (1V) per panel
Single Door Width	31.501" - 38.812"	=3 lites across (2V) per panel
Door Height	Up to 84"	=5 lites down (4V) per panel
Door Height	84" - 96"	=6 lites down (5V) per panel

STANDARD LITES FOR COLONIAL GRIDS

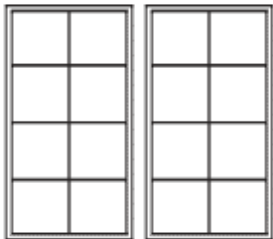

Double French Door		
Double Door Width	Up to 62"	=2 lites across (1V) per panel
Double Door Width	62.001" - 76"	=3 lites across (2V) per panel
Door Height	Up to 84"	=5 lites down (4V) per panel
Door Height	84" - 96"	=6 lites down (5V) per panel



INVENT. BUILD. DELIVER.

A collection of the best brands in windows and doors coming together to invent, build, and deliver the highest-quality and safest products in the fenestration industry.

THE PGT INNOVATIONS FAMILY OF BRANDS



PGTWINDOWS.COM | N. VENICE, FL

©2020 PGT CUSTOM WINDOWS + DOORS. A PGT INNOVATIONS BRAND.

05/20 ME0300575