



PGT EnergyVue®

PGT WinGuard®
VINYL

HR5410 / HR5510

This reference guide is to help identify parts and ordering options.

FRAME PARTS



WOOD-red
(automatically engages)

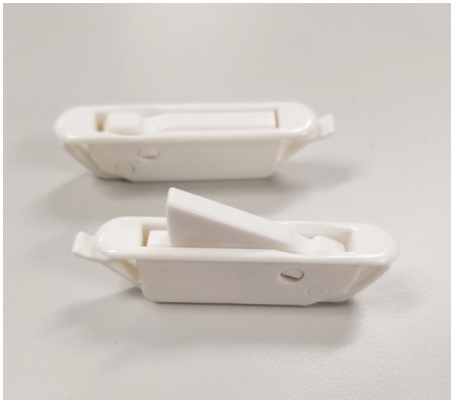

Vent latches
(manually engages)

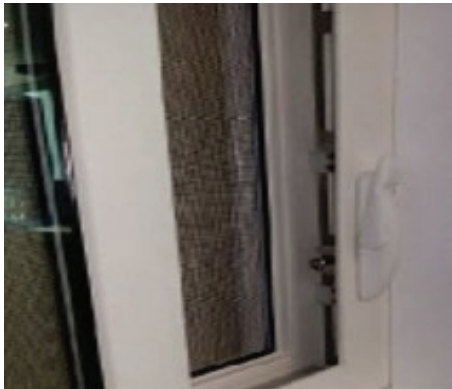

Egress lock
(cannot be done in the field)



0.438" installation hole plug
(color matched to frame)



Fin seal weather strip
(frame meeting rail, perimeter of sash)

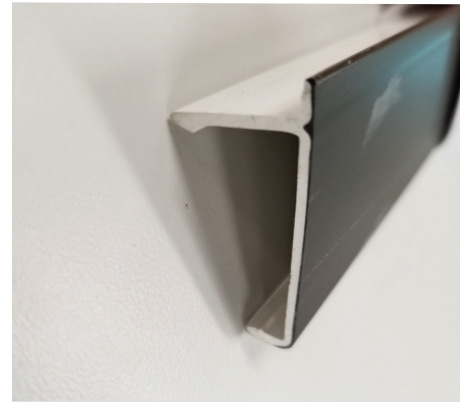

Fastener cover
(in the head and jamb of the fixed side)



Roller track insert

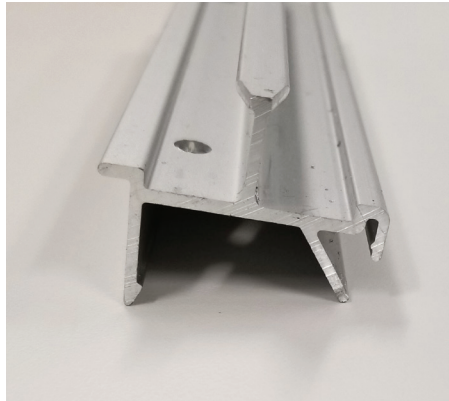

Monorail



Interlock fir pad



Clip on sash stop



Keeper
(color matched to frame)



Weep hole cover
(color matched to frame)

SASH PARTS

Secure connect sash corner technology – Wheel housing



Wheel housing lead stile
(top & bottom of pull rail)



RH/LH pull rail
wheel housing
(bottom toward exterior)



Mono corner key
(Top of sash toward exterior)



Roller wheels



Sash lock
(color matched to frame)



Upgraded sash lock finish
*Oil rubbed bronze, Brushed nickel,
Antique brass*



Fin seal weather-strip
*(sill on the exterior of home,
meeting rail on the interior of frame)*



Sash pull rail/interlock cover

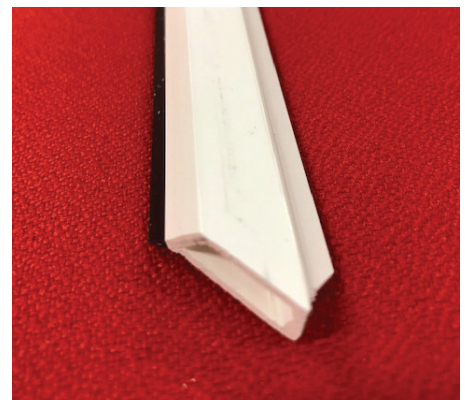

IG bead
(varies depending on glass type)

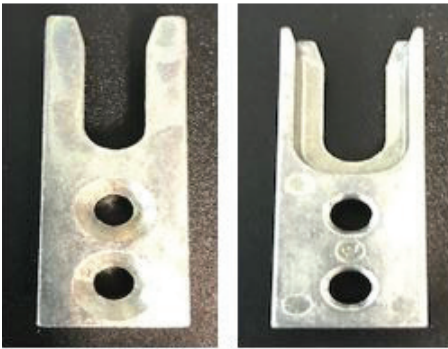

Multi point keeper

SCREEN PARTS



Screen corner key - extruded



Screen corner key - roll form



Tension spring

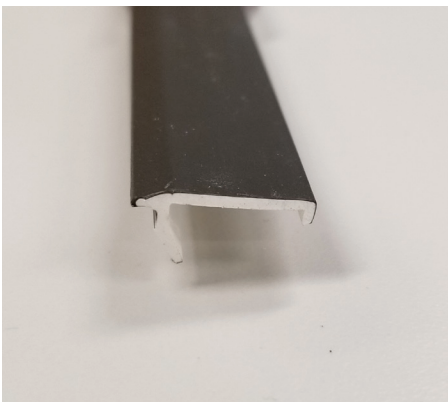

Screen adapter

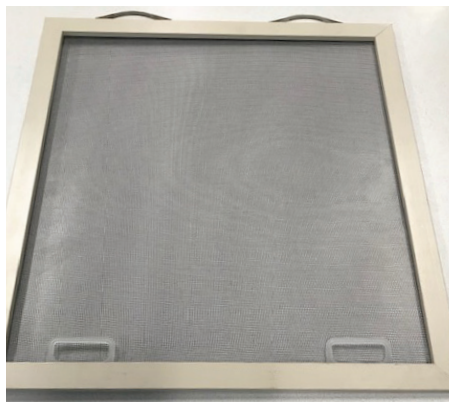

Extruded screen



Roll form screen

EXPLODED VIEWS

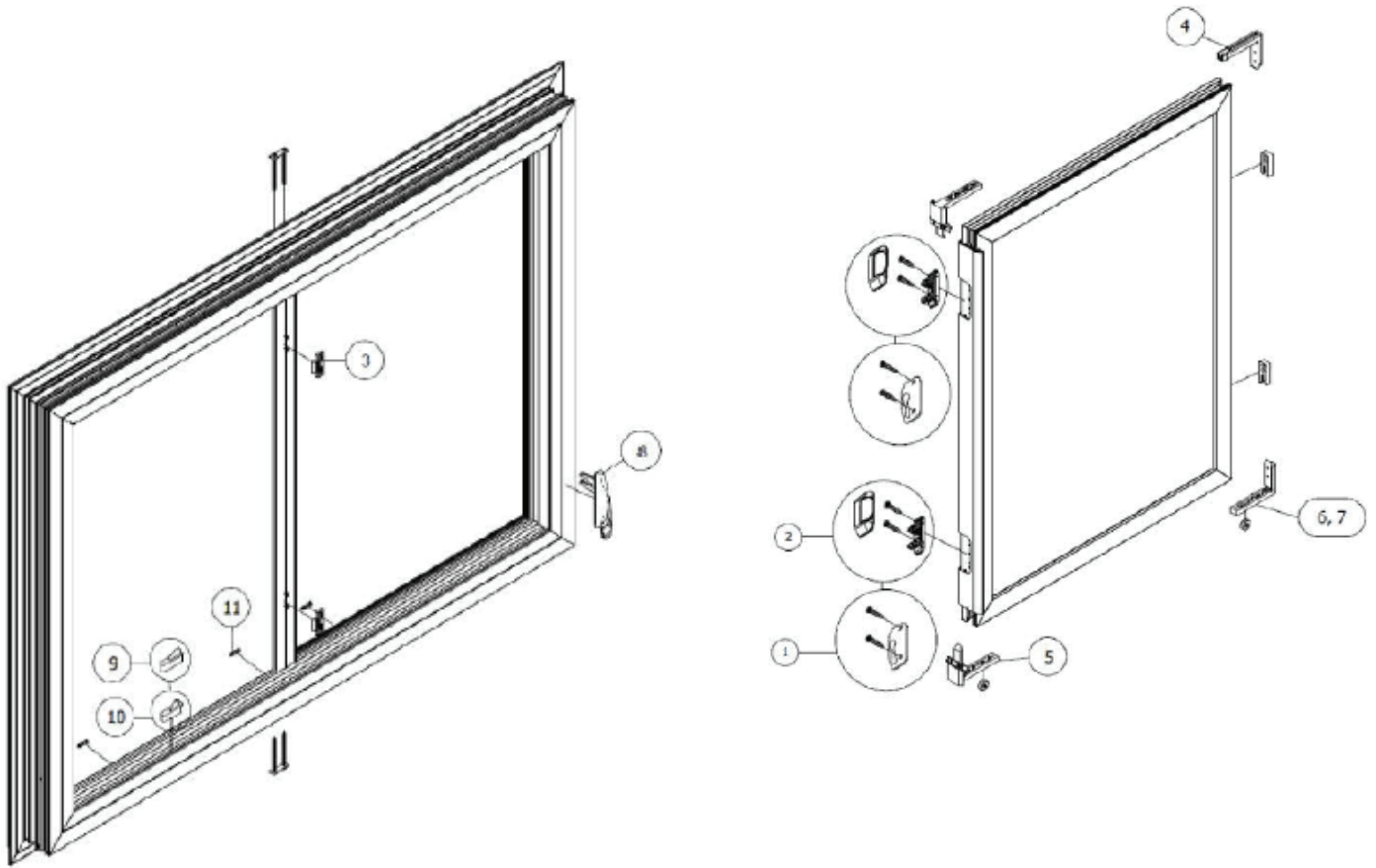

PARTS LIST	
ITEM	NAME
1	Sweep Lock with Screws
2	SnapLock Cover, Mechanism with Screws
3	Keeper
4	SecureConnect Impact Retain Clip (HR5510 only)
5	SecureConnect Lock Rail Wheel Assembly with Fin Seal and Screws
6	SecureConnect Wheel Assembly (No Wheels)
7	SecureConnect Wheel Assembly with Fin Seal and Screws
8	Egress Lock
9	Vent Latch
10	Window Opening Control Device (WOCD)
11	Weep Hole Cover
12	7/16" Installation Hole Plug