

Sliding Glass Door Assembly Instructions











SERIES 670/770

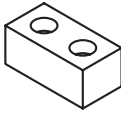

CUSTOM WINDOWS + DOORS

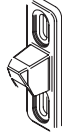
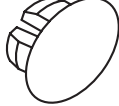

670/770 Parts List

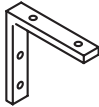
PARTS			
DESCRIPTION		PARTS BAG QTY.	
	FRAME ASS'Y SCREW #8 x 1" LONG	16 per bag	
	Screw used to assemble the main frame.		
	JAMB BUMPER SCREW #6 x 3/8" LONG	1 per bumper	
	Screw used to attach the jamb bumper to the operable panel.		
	COME - A - LONG SCREW #8 x 1 1/4" LONG	2 per come - a - long	
	Screw used to attach the come -a- long block to each operable panels.		
	4 HOLE BUMPER STOP SCREW #8 x 3/8" LONG	4 per bumper	
	Screw used to attach the 4 hole bumper stop to sill and head.		
	COME - A - LONG AND COVER	1 per operable panel	
	Used on the top of operable panels at interlock. Used on multi panel configurations only.		
	SCREEN KEEPER SPACER	1 per screen keeper	
	Shim used to raise screen keeper off of frame for additional adjustment.		
	HEAVY DUTY 4 HOLE BUMPER STOP	2 per operable panel	
	Reinforced vinyl stop attaches to header & sill of the main frame. Used to prevent the "X" panel from impacting components adjacent to it. Also prevents pocket panels from rolling off the track.		
	FIXED PANEL CLIP (6" LONG)	1 per "O" panel	
	An aluminum clip that attaches to the panel stile & main frame jamb. Used to fix the "O" panel in place.		
	FIXED PANEL RETAINERS	2 per "O" panel	
	There are 2 different retaining clips., one for fixed panels that are on the inner most track of the home (Track 1) and one for fixed panels that are on all other tracks.		
	SCREEN LATCH KEEPER	1 per operable screen	
	Screen latch keeper is used with the standard panel pull on the box screen. Attaches to the main frame jamb to allow the screen to lock in to the jamb.		
	ROLLER ADJUST HOLE PLUG	2 per panel	
	Round plug used to fill the hole for the adjustment screw on the rollers.		
	JAMB BUMPER	1 per main frame jamb	
	Attached to the stile. It keeps the panel from making contact with the main frame.		
	DUST PLUG (HIGH)	2 at each interlock connection	
	Used on the main frame at the top / bottom of every operable panel interlock connection.		
	"O" PANEL BRACKET High-Performance Doors Only	1 per fixed panel	
	Used to fix the "O" Panels to the Head Only.		

670/770 Parts List

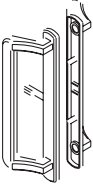
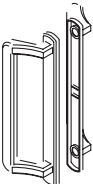
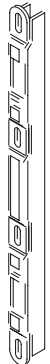
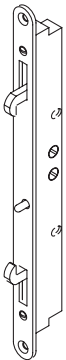
PARTS			
DESCRIPTION		PARTS BAG QTY.	DESCRIPTION
	MORTISE LOCK RAISED HANDLE SET (ACTIVE)	1 per lockstile panel	RECESSED LOCK (ACTIVE)
	<p>Standard handle set provided to lock the door. Handle set comes complete with two metal handles, one on the interior & one on the exterior with color match screws.</p>		<p>Optional handle set provided to lock the door. Comes complete with two metal handles, one on the interior & one on the exterior with color match screws.</p> <p>* Also used as secondary locks when recessed locks are ordered as Primary Locks.</p>
	MORTISE LOCK RAISED HANDLE SET (INACTIVE)	1 per astragal	RECESSED LOCK (INACTIVE)
	<p>Used with Standard raised handle set when door has Astragal panels. Comes complete with two metal handles, one on the interior & one on the exterior with color match screws. Not used on OXO configurations.</p>		<p>Used with recessed handle set when door has Astragal panels. Comes complete with two metal handles, one on the interior & one on the exterior with color match screws.</p>
	1" MORTISE LOCK KEEPER	1 per Mortise latch	SECONDARY LOCK THUMBTURN
	<p>The lock keeper is placed on the main frame jamb or the astragal. This allows the panel to lock into the main frame or lock into the astragal panel.</p>		<p>Optional secondary lock used with Mortise Raised handle set.</p>
	MORTISE LATCH	1 per Mortise latch	EXTERIOR FLATPLATE
	<p>Factory installed dual point Mortise Latch used to lock the doors.</p>		<p>Used with Interior Raised handle set when a low profile is needed on the Exterior.</p> <p>* Will not be anything to grab to hold the doors.</p>
<p>BAG MAY BE SENT WITH EXTRA PARTS TO ACCOUNT FOR LOSS OR MISPLACEMENT OF SMALL PIECES.</p>			
<p>PLEASE MAKE SURE PRIOR TO ASSEMBLY THAT YOU HAVE THE CORRECT AMOUNT OF PARTS CALLED OUT FOR BY THE "PARTS BAG QTY" SECTION.</p>			

NOTICE

CAREFULLY FOLLOWING THE INSTRUCTIONS IN THE PROPER SEQUENCE WILL REDUCE MISTAKES AND SAVE TIME.

- Protect mainframe only with light coating of oil, grease or soap. Action of lime in plaster can destroy finish.
- Sill must be smooth ... buff edges and fill any valleys left by mason. A ridge or lump could cause latching problems.
- If installed in wood surround, measure assembled door frame, add shim space and make surround to these dimensions.
- A Parts List is provided at the front of this document for quick reference. Inspect the product and take inventory of all parts and pieces prior to installation. (ex. screws, frame, panel, etc.)
- **Exploded View Reference(s)** at the front of this document act as a reference for general location of parts and depict figures that are referenced when following steps outlined in these instructions.
- Carefully review these assembly instructions along with installation details contained in the AAMA Specifications, Miami-Dade Notice of Approval, or test reports, including anchorage information, if applicable.

SECTION 1: FRAME ASSEMBLY BY-PASS

(if pocket door skip to pocket section)

1. Gather the main frame header, sill and jambs. Trace the frame ends with sealant. (See Figure 1)

Note: It is good practice to seal the outside of all four corners heavily after the frame is assembled. (See Figure 1 and 2)

2. Assemble mainframe head, jambs, and sill using the supplied # 8 x 1 Philips pan head screws at each assembly hole. (See Figures 1 and 2)

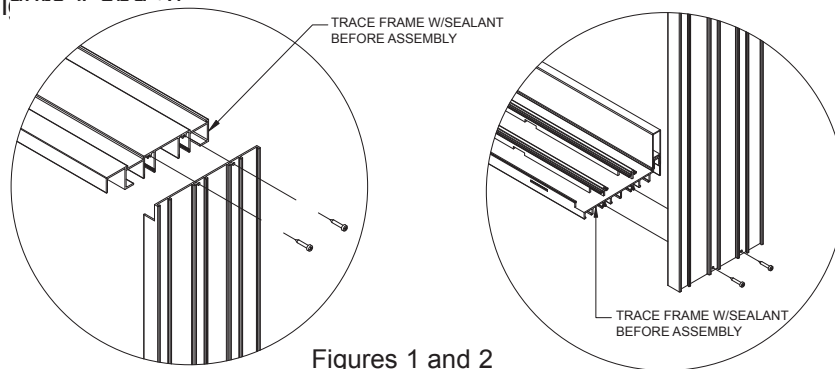

3. Apply the sill riser adapter to the main frame sill. First, place sealant along entire length of riser adaptor in area shown (See Figure 3).

4. Set the track on an even, flat, fully supported surface and then connect the sill riser to the sill. (See Figure 3a).

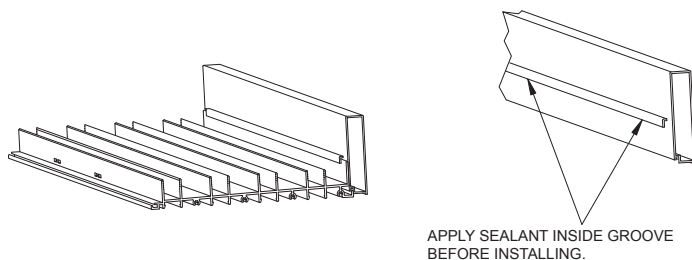

Note: Risers can be applied at the end of the installation as well should panels need to be set from the inside or to protect from job site damage. When using the Box (standard) riser allow for the additional depth the riser will add to the sill towards the inside. If this additional depth is not accounted for there may not be enough room to install the riser. It is recommended that the sill riser be attached (without sealant) until the main frame is secured.

5. Make sure the opening which the door is to be installed to is clean and clear of debris. Dry fit the frame into the opening.

Note: Do not force the frame into the opening. If the frame is tight then clear away obstructions.

6. Once the frame fits into opening freely, seal under entire length of sill and all frame seams. Make sure to include where the frame sill and head meet the main frame jambs. (See Figure 4)

7. Set frame in opening and shim as necessary to make frame plumb, level and square. Shim behind all frame jamb and header installation screws and near mortise keeper to prevent frame distortion when installation screws are tightened.

Important: Frame head and track must be level, square and plumb at frame jambs. Measure at head, sill and midpoint horizontally to be certain that frame is not bowed, also measure from top to bottom across the entire frame from left to right to make sure there are no rises in the sill or dips in the header. Rises in the sill or dips in the header could prevent the panels from being installed. Do not over tighten frame installation screws as this could warp the frame. (See Figure 5)

Helpful Tip: Use a short torpedo level across the sill (without setting it on the riser) and at the head to verify the sill and head are level from inside to outside. If the track at sill or head are not level from inside to outside it could cause stiff panel operation. Take notice that the head and sill are not the same depth, it is important to make sure that the tracks align at the head and sill in order for the panels to roll correctly. Use a plumb bob to make sure the head and sill are in alignment, this is especially important in pocket conditions.

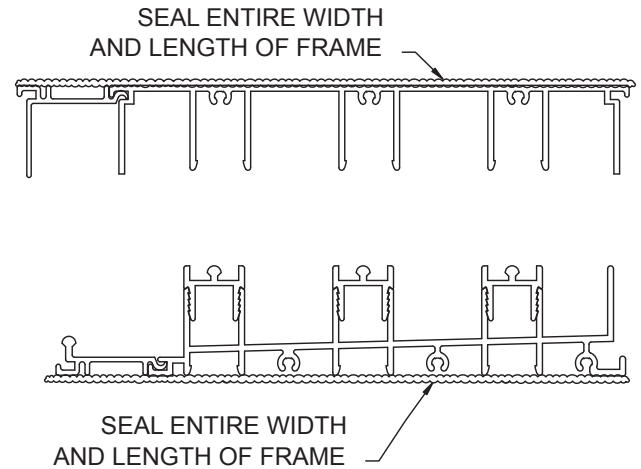

Figure 4

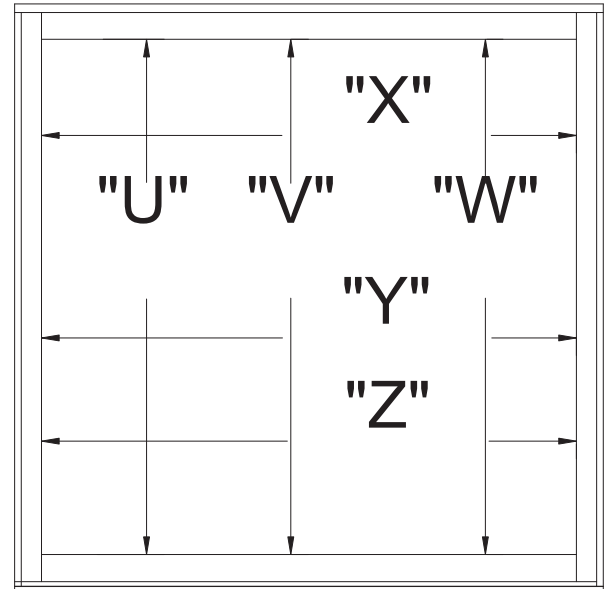

Figure 5

8. Attach frame to opening per PGT specifications and in compliance with all local code requirements, Miami-Dade NOA or test reports.

9. Once the frame is secured and is plumb, level, and square, seal installation screws.

10. After installation screws are sealed, install the sill inserts. There is one insert for each track. (See Figure 6)

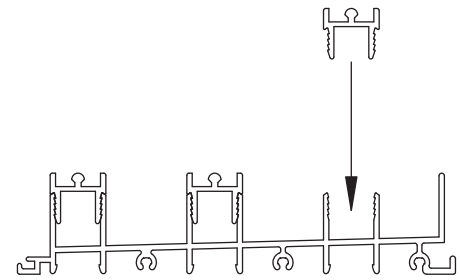

Figure 6

11. Next install the main frame head screw covers. Snap the screw cover in on one side then slide the cover over until it is past the jamb fins, do the same with the other side. The material may need to be arched to get it in tight. (See Figure 7)

Note: Main frame jamb screw covers in tracks where keepers or fixed panel clips will be installed should be installed at the end of installation. This allows for proper placement and adjustment of keepers and clips. The main frame jamb screw covers will need to be trimmed to size once keepers have been adjusted.

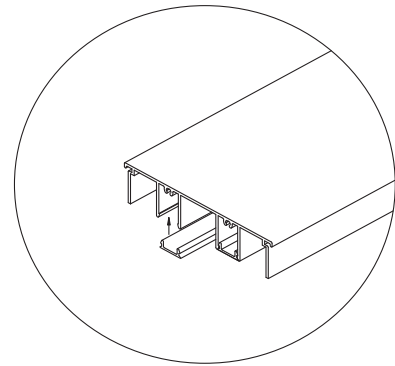

Figure 7

SECTION 2: FRAME ASSEMBLY POCKET

(if pocket door skip to pocket section)

1. Gather the main frame header, sill and jamb (if single pocket). Trace the frame head and sill ends with sealant on jamb side of single pocket doors. It is not necessary to trace the frame ends if the unit is a double pocket door. (See Figure 8 and 9)

Note: It is good practice to seal heavily the outside of all corners where the frame head and sill meet a jamb after the frame is assembled. Not available on double pockets.

2. Assemble mainframe head, sill, and jamb, on a single pocket door using the supplied # 8 x 1 Philips pan head screws at each assembly hole. (See Figure 8 and 9) This step is not required on double pocket units.

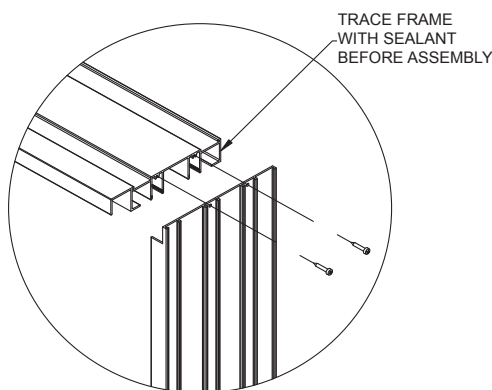

Figure 8

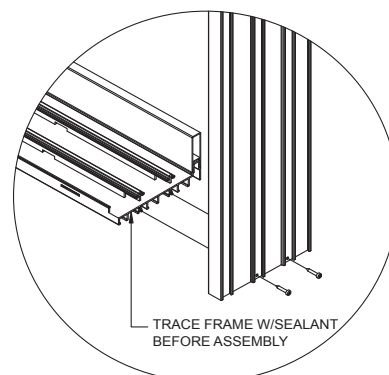

Figure 9

3. Apply the sill riser adapter to the main frame sill. First, place sealant along entire length of riser adaptor in area shown (See Figure 10).

4. Set the track on an even, flat, fully supported surface and then connect the sill riser to the sill. (See Figure 11).

Important: Sill riser must be installed prior to the p-hook being installed.

Note: Sill riser can be attached near the end of the installation but must be attached prior to installation of the p-hook should panels need to be set from the inside or to protect from job site damage. When using the box (standard) riser allow for the additional depth the riser will add to the sill towards the inside. If this additional depth is not accounted for there may not be enough room to install the riser. It is recommended that the sill riser be attached (without sealant) until the main frame is secured.

5. Make sure the opening which the door is to be installed is clean and clear of debris. Dry fit the frame into the opening.

Note: Do not force the frame into the opening. If the frame is tight then clear away obstructions.

6. Once the frame fits into opening freely, seal under entire length of sill and all frame seams. Make sure to include where the frame sill and head meet the main frame jamb if the unit is a single pocket. (See Figure 12)

7. Set frame in opening and shim as necessary to make frame plumb, level and square. Shim behind all frame jamb and header installation screws and near mortise keeper to prevent frame distortion when installation screws are tightened.

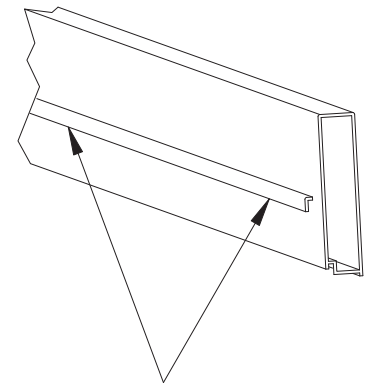

APPLY SEALANT INSIDE GROOVE
BEFORE INSTALLING.

Figure 10

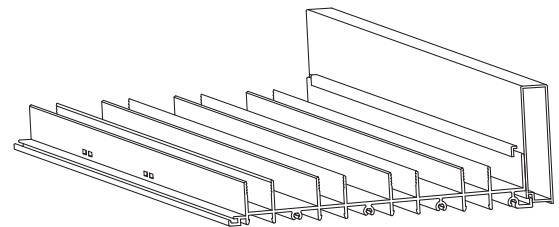
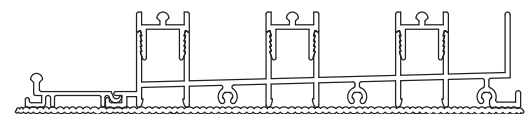
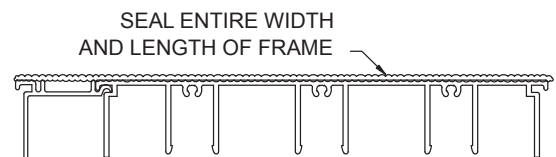

Figure 11



SEAL ENTIRE WIDTH
AND LENGTH OF FRAME

Figure 12

Important: Frame head and track must be level, square and frame jamb (if used) must be plumb at jamb. Measure at head, sill and mid point horizontally to be certain that frame is not bowed, also measure from top to bottom across the entire frame from left to right to make sure there are no rises in the sill or dips in the header. Rises in the sill or dips in the header could prevent the panels from getting installed. Do not over tighten frame installation screws this could warp the frame. (See Figure 13)

Helpful Tip: Use a short torpedo level across the sill (without setting it on the riser) and at the head to verify the sill and head are level from inside to outside. If the track at sill or head are not level from inside to outside it could cause stiff panel operation. Take notice that the head and sill are not the same depth, it is important to make sure that the tracks align at the head and sill in order for the panels to roll correctly. Use a plumb bob to make sure the head and sill are in alignment, this is especially important in pocket conditions.

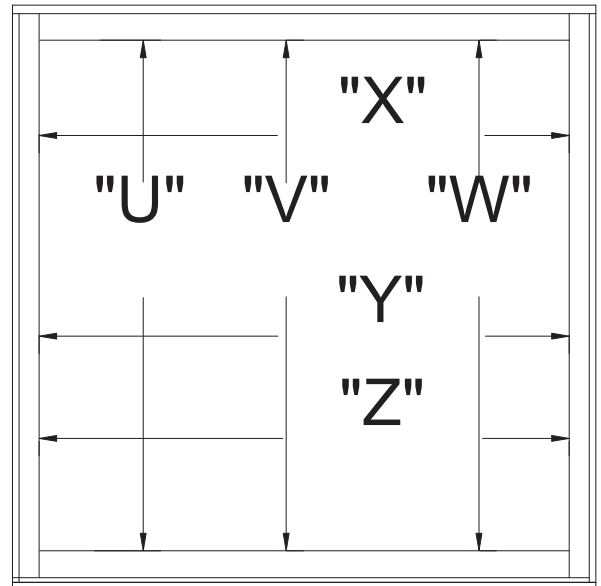

Figure 13

8. Attach frame to opening as per PGT specifications and in compliance with all local code requirements, Miami-Dade NOA or test reports.

9. Next attach the P-hook.

Note: Pocket doors will only assemble at head, jamb and sill if single pocket. Double pocket main frame is not assembled as there are no jambs supplied with the unit.

10. Hook strip P-hook will attach interior panel to substrate. Attach frame and hook strip to opening as per PGT specifications and in compliance with all local code requirements, Miami-Dade NOA or test reports.

11. The P-hook is not notched and sits on top of the sill and just under the header. There are two types of P-hooks, one for the narrow sill riser and one for the box (standard) riser. (See Figure 14)

12. If a panel is not available to set the location of the p-hook from inside to outside then align the p-hook with the riser and header as shown. (See Figure 15)

Note: Note: riser heights will determine how many dust plugs will be needed at the sill. Install as many as needed to fill the void from the bottom of the panel to the underside of the P-hook

13. Once the frame is secured and is plumb, level, and square; seal installation screws.

14. After installation screws are sealed, install the sill inserts. There is one insert for each track. (See Figure 16)

15. Next install the main frame head screw covers and P-hook screw covers. (See Figure 17)

Note: For pocket doors with main frame jambs - the main frame jamb screw covers conceal where the keepers will be mounted and should be installed at the end of installation. This will allow for proper placement and adjustment of keepers. The main frame jamb screw covers will need to be trimmed to size once keepers have been adjusted.

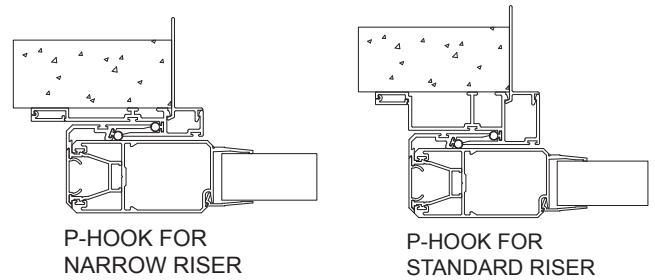

Figure 14

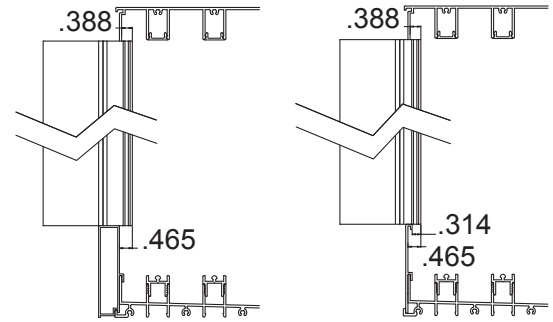

Figure 15

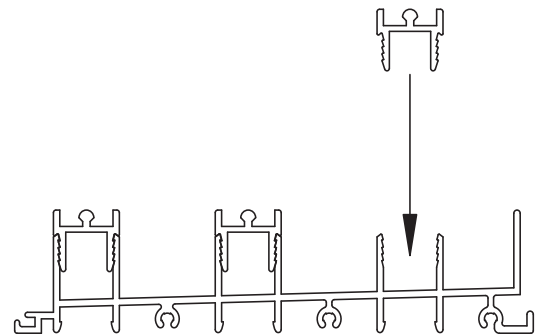

Figure 16

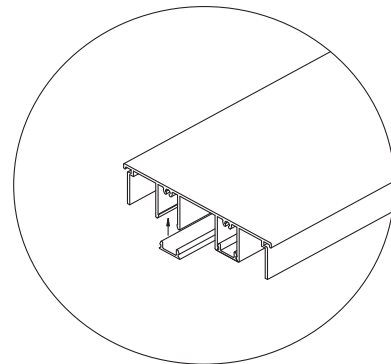

Figure 17

SECTION 3: PANEL INSTALLATION

PGT offers many sliding glass door configurations, please see the panel orientation sheet to make sure the correct panels are on the correct tracks.

1. Shipping labels on panels will have the panel # and letter name on them; they will be installed in order from left to right. Please see the configuration page for the proper track the panel goes onto. (See Figure 18)

2. Position panel so that the top of panel slips over track frame header. Swing bottom of panel in until bottom of panel is aligned over sill and set panel on roller spline. (See Figure 19)

3. Repeat procedure, with next outer panel until all panels are installed.

4. Panels are always installed with roller adjustment holes to the exterior.

- To adjust rollers on panels use a Phillips head screwdriver to turn adjustment screws located on the bottom outside of panel. Screw guns can strip the adjustment and therefore are not recommended. (See Figure 20)

5. To raise panels, pick up the panel at the edge to relieve the weight pressure on the wheels and then adjust by turning adjustment screw clockwise. To lower panels turn adjustment screws counter clockwise then use weight pressure on the panel to set the wheels to the new adjustment level. (See Figure 21)

WARNING: When raising and lowering the wheels, if you feel pressure do not continue as this could cause the adjustment screw to strip. Adjust each panel until all panels roll freely and all panels' stiles and frame jambs are parallel when in the closed position.

6. Once all panels are set into place and have been adjusted properly, check the reveals and operations to verify that everything is in proper working order. You are now ready to start to install the hardware.

It is recommended to install the locking hardware BEFORE attaching any of the fixed panel hardware.

Locking Hardware Door to Jamb Connection (See Figure 22)

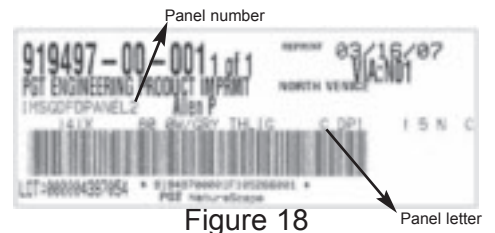

Figure 18

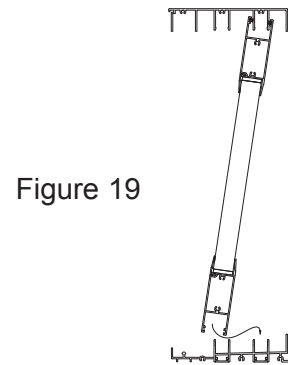

Figure 19



Figure 20

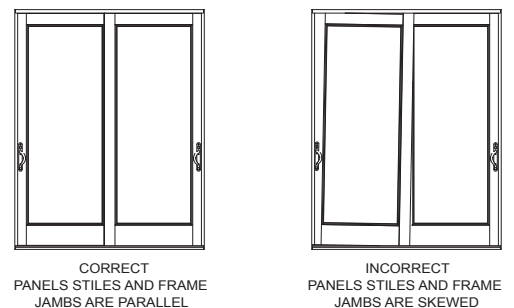

Figure 21

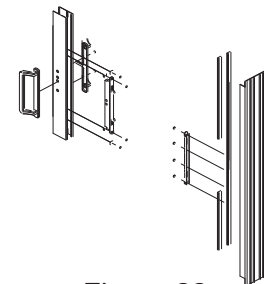

Figure 22

1. Align the thumb turn tail piece of the interior handle into the slot of the mortise assembly.

2. Attach handles using the two (2) #8-32 pan head screws provided.

Note: Latch may not be operated unless the safety pin (located between the two mortise cams) is depressed.

SECTION 4: KEEPER INSTALLATION

3. Attach keeper to frame jamb using four (4) #10 X 1 1/2" pan head screws. Track will be dimpled in the location the keeper is installed into the frame jamb.

4. With the mortise lock latch extended, adjust the keeper to maximize bite with the latch. Check operation of the lock and adjust the keeper up or down if required.

HELPFUL TIP: There is adjustment on the latch to move the cams in or out. Adjust the cams independently to remove play or add play to the latch engagement in the panel. If the unit has fixed panels it is recommended to adjust the cams in tight until the fixed panel is secured. Once the fixed panel(s), fixed panel clip(s), and retainer clip(s), have been completely installed readjust cams to allow for a little bit of play in the operating door(s). (See Figure 23)

SECTION 5: LOCKING HARDWARE

Door to Door Connection (See Figure 24)

1. Align the lever tail piece of the interior handle into the slot of the mortise assembly.

2. Attach handles using the two (2) #8-32 pan head screws provided.

a. Note: latch may not be operated unless the safety pin (located between the two mortise cams) is depressed.

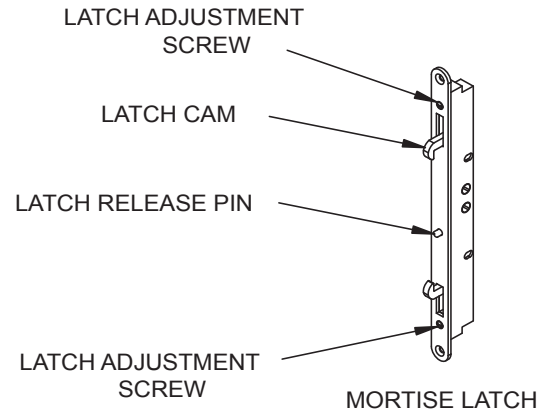

Figure 23

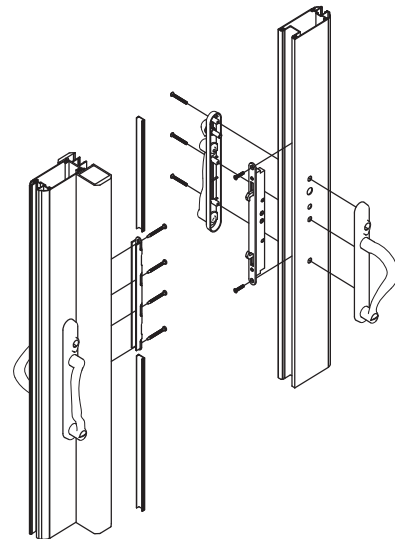

Figure 24

SECTION 6: KEEPER INSTALLATION

3. Attach keeper to frame jamb using four (4) #10 X 1 1/2" pan head screws. Astragal will be dimpled in the location the keeper is installed into the frame jamb.

4. With the mortise lock latch extended, adjust the keeper to maximize bite with the latch. Check operation of the lock and adjust the keeper up or down if required.

HELPFUL TIP: There is adjustment on the latch to move the cams in or out. Adjust the cams independently to remove play or add play to the latch engagement in the panel. If the unit has fixed panels it is recommended to adjust the cams in tight until the fixed panel is secured. Once the fixed panel(s), fixed panel clip(s), and retainer clip(s), have been completely installed, readjust cams to allow for a little bit of play in the operating door(s). (See Figure 25)

5. If the door has the recessed hardware or any secondary lock hardware, follow the same procedures listed above.

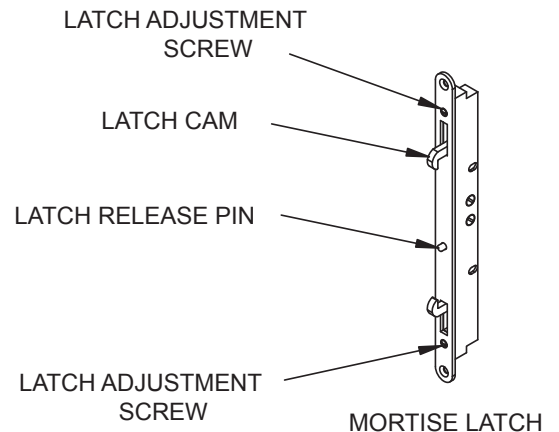

Figure 25

SECTION 7: FIXED PANEL HARDWARE

1. Each fixed panel has one 6" fixed panel clip and one retaining clip.

2. The fixed panel clip will snap into the main frame jamb at the center of the height of the jamb. Attach the clip to the main frame jamb by tapping it into place with a hard plastic mallet.

Note: Be sure the "Fins" on the clip are facing the interior of the house. (See Figure 26)

3. Once the clip is snapped firmly into place on the frame jamb and the fins are positioned to the inside of the house, lock the operating panels to the main frame jamb with the mortise lock cams adjusted all the way in, then close the fixed panels over the fixed panel clip.

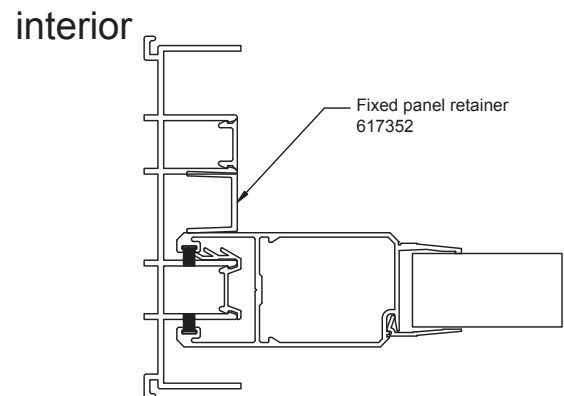

Figure 26

4. The fins from the clip will make interference with the stile and lock the panel into place.

5. Once the fixed panels are locked into place, install the retaining clip. The clip is installed on the interior of the home and will fit between the stile of the door and the main frame jamb leg. Retaining clips are the full height of the panel.

Note: The retaining clip must be installed so that the panel cannot be pushed on from the exterior and disengaged from the fixed panel clip. There are two different retaining clips, one for fixed panels that are on the inner most track of the home (Track 1) and one for fixed panels that are on all other tracks.

Be sure to reference the test report or Miami-Dade NOA for proper quantity and placement of the fixed panel clips.

SECTION 8: SCREEN FRAME INSTALLATION (Box Screen)

Note: Screen main frame will be separate from panel main frame when exceeding two tracks. If the unit is a 2P2T, 3P2T, 4P2T this section does not apply, skip to the next section. If the unit does not have screens, please skip to the next section.

Screen Frame Assembly

1. The screen frame head, jambs, and sill must be installed into the main frame head, jambs, and sill.

2. Start with the screen sill; it will connect into the main frame sill accessory groove.

3. Insert tail piece and rotate downward locking it into place. (See Figure 27)

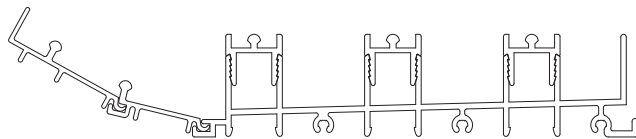

Figure 27

4. Next connect the screen head add-on to the main frame head accessory groove.

5. Insert tail piece and rotate upwards locking it into place. (See Figure 28)

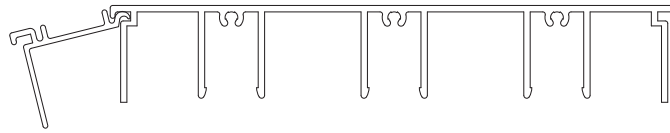

Figure 28

6. Last, connect the screen frame jambs to the main frame jambs

7. Insert tail piece and rotate outwards until they are locked into place (See Figure 29)

Note: There are not any anchorage requirements for the screen frame so attach as needed to hold the screen frame into place.

8. Seal under entire length of sill and all frame seams and also apply a small amount of sealant where screen mainframe and glass door main frame meet.

9. Shim as necessary to make screen frame plumb, level and square. Shim behind all frame jamb and header installation screws and near keeper to prevent frame distortion when installation screws are tightened.

Note: Frame head and track must be level and frame jamb must be plumb at jambs. Measure at head, track and latch to be certain that frame is not bowed. Do not over tighten frame installation screws this will warp the frame and prevent the screen(s) from operating properly.

Note: If unit is an OXO then the screen astragal adapter and screen astragal will need to be installed. It will be installed at the end of the installation and is in the parts and pieces section of this Assembly Instruction Manual.

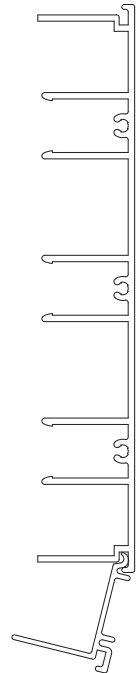

Figure 29

SECTION 9: SCREEN FRAME INSTALLATION (STANDARD SCREEN)

If the unit does not have screens, please skip to the next section. The standard screen rides on the same mainframe as the glass panels with the addition of one sill screen/finishing rail.

10. Attach the standard screen rail to the main frame by inserting the tail piece into the main frame sill accessory groove and rotate downward. (See Figure 30)

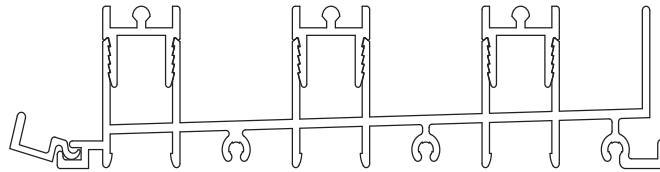

Figure 30

Note: There are not any anchorage requirements for the screen frame, so attach as needed to hold the screen frame into place.

11. Seal under entire length of sill and all frame seams and also apply a small amount of sealant where screen mainframe and glass door main frame meet.

12. Shim as necessary to make screen sill plumb, level and square.

Note: If unit is an OXO then the screen astragal adapter and screen astragal will need to be installed. It will be installed at the end of the installation and is in the parts and pieces section of this assembly instruction manual.

SECTION 10: SCREEN PANEL INSTALLATION (Box Screen)

1. Position panel so that top of panel slips into frame header channel. Swing bottom of panel in until bottom of panel is aligned over sill spline and set panel on roller spline. (See Figure 31)

2. Repeat procedure, with next in line or outer screen until all screens are installed. Please see the con figuration page for the track the screens go on to.

3. Adjust screen rollers located at ends of screen panel.

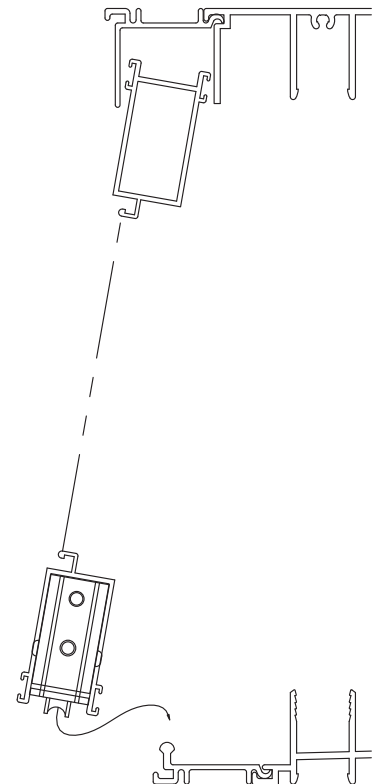

Figure 31

WARNING: When raising and lowering the wheels, if you feel pressure do not continue as this could cause the adjustment screw to strip. Adjust each screen until all screens roll freely and all screen stiles and frame jambs are parallel.

4. When screens are properly adjusted, latch keepers may be installed and raised or lowered to make proper contact with latch P-cam.

SECTION 11: SCREEN PANEL INSTALLATION (Standard screen)

1. Position panel so that top of panel slips onto frame header fin. Swing bottom of panel in until bottom of panel is aligned over sill add on fin and set panel roller on fin. (See Figure 32)

2. Repeat procedure, with next in line screen until all screens are installed. Please see the configuration page for the track the screens go on to.

3. Adjust screen rollers located at top and bottom of screen at each end.

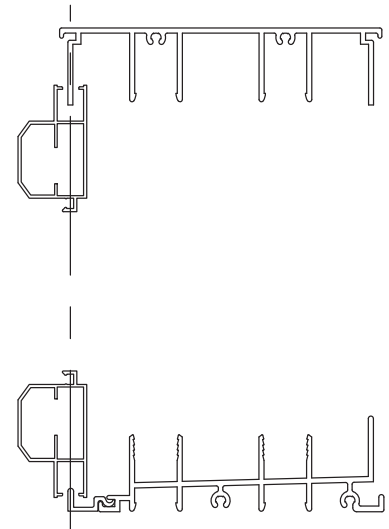

Figure 32

SECTION 12: PARTS AND PIECES

After the above steps have been completed, the unit is operating properly, and is set in place you are ready for the final parts and pieces.

High Pile Dust Plugs

Dust plugs are used to fill any voids where interlocking panels are set in the closed position and require a weather seal. Position two high pile pads above and below the interlocking section of the doors in the closed position.

To do this, mark the area where the doors interlock together in the closed position. Then open the panels and place the high pile pads on the extrusion making sure that the adhesive backing makes good contact to the extrusion. (See Figure 33)

Note: Pocket doors will also require a dust plug added to the head and sill facing the interlocking panel. (See Figure 34)

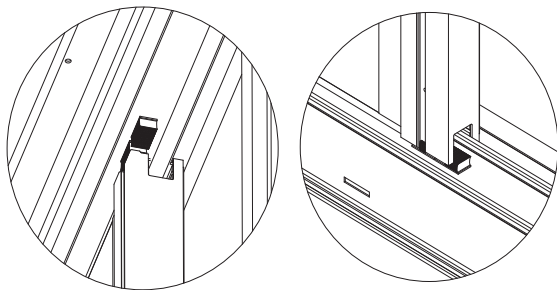

Figure 33

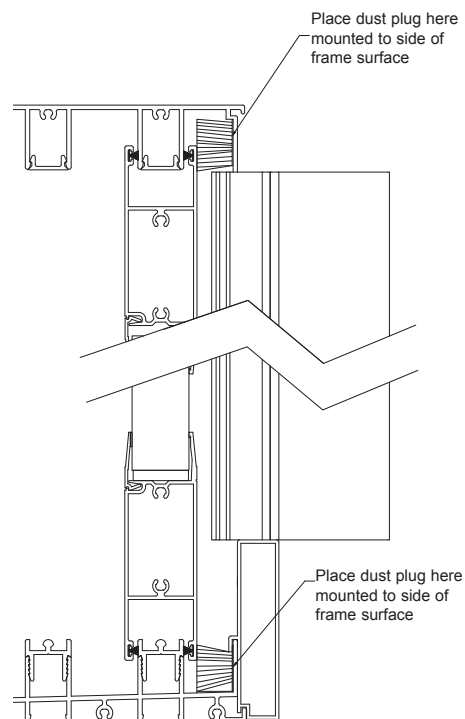

Figure 34

Panel Bumpers

The four hole bumper stop can be used to stop the travel of a panel on a by-pass or to keep a panel from rolling off the track when installing a pocket door. For a bypass it should be placed in the header and/or on the sill in such a way to keep the locking handle from making contact with the next door's interlock. On a pocket door unit it should be installed to keep a panel from rolling off of the end of a track.

(See Figure 35)

Note: For multiple panel units it may be necessary to also use the panel come-a-long in conjunction with the four hole bumper stops.

Panel Come-A-Long

If the unit is a multi-panel, multi-track or pocket door unit it may be necessary to install panel come-a-longs. This allows the door to open without having to move each panel individually and also keeps the panels from hitting the interlocks or making contact with the handle hardware. They may be installed at the top of the door panel.

(See Figure 36)

The come-a-long should be located in front of the vertical stile at the top rail. As the panel moves down the track it will make contact with the panel come-a-long and start driving the next panel down the track. It installs with two number 8" x 1 1/4" sheet metal screws. When located in the correct position it should leave a gap between the handle and the interlock of the panel.

Note: Installing come-a-longs in the bottom rail of the panel could prohibit the roller from operating correctly as the screw could bind into the roller housing.

Note: Do not locate the part in any other area than shown in the drawing; doing so could cause damage to the frame or glass. Do not use longer screws; doing so could cause interference or operational problems.

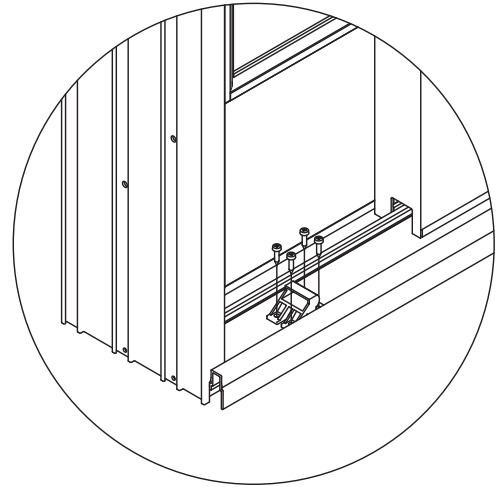

Figure 35

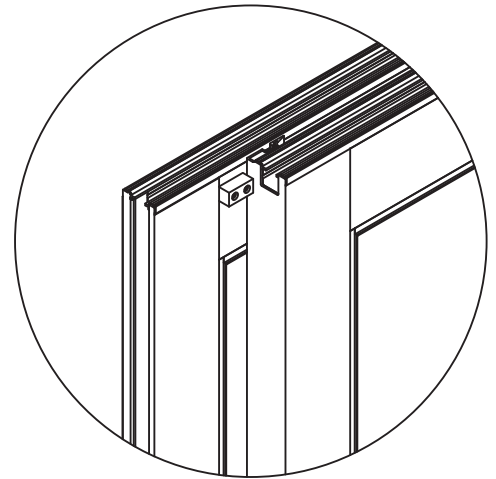

Figure 36

Adjustment Hole Plug

Once the doors are installed and working properly, install the roller adjustment hole plugs. There are two per operable panel and should be located on the outside face of the door.

(See Figure 37)

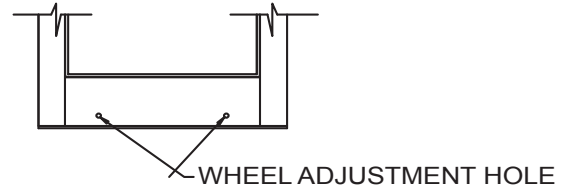

Figure 37

Screen Astragal and Screen Astragal Adapter

If the unit has screens and is an OXO configuration, then the screen astragal and screen astragal adapter will need to be installed. Slide the screen astragal into the screen astragal adapter. Take the assembled part and install it onto the astragal base. This is applied to the exterior of the stationary panel's astragal base as shown in the drawing.

Use four #10 x 3/4" self drilling screws to attach the astragal adapter and astragal to the glass panels astragal base. Once installed latch keepers may be installed and raised or lowered to make proper contact with latch P-cam. Caulk any seams where the astragal adapter and astragal meets head or sill. (See Figure 38)

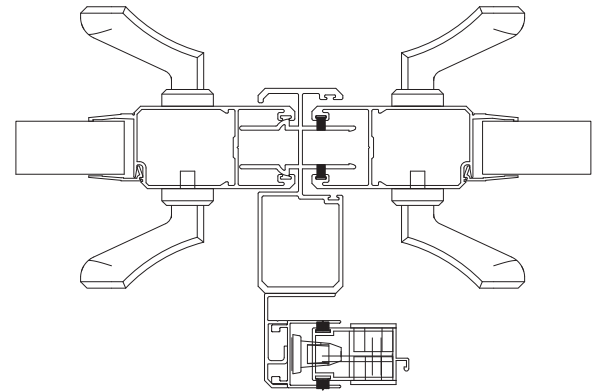

Figure 38

Final Screw Covers

Once the installation is complete, install any remaining screw covers. This includes screw covers that need to be cut to size that fit above and below the frame jamb keepers or astragal keepers. If the unit is a pocket door, there will also be a screw cover for the screws on the P-hook.

SECTION 13: Special Feature Note:

This door has unique features that allow for versatility in the field.

Here is an additional feature for the advanced user.

Changing the Stack:

The interlock design used on this product allows the panels to move from interior tracks to outer tracks thus reversing the stack of the unit without requiring the glass to be deglazed from the product. Not all units are capable of stack reversal. See Configuration Drawings to verify.







Steps to reversing the stack:

1. Remove the panel from the opening
2. Lay the panel down on a saw horse or supported surface
3. Remove the interlock screw cover
4. Remove the screws attaching the interlock to the stile
5. Slide the interlock off the top or bottom, notice the two barbs that fit inside the weather-strip groove
6. Flip the interlock so that it is now facing the other direction
7. Slide the interlock back into place making sure the barbs are in the weather-strip groove.
8. Reinstall the interlock screws
9. Reattach the interlock screw cover
10. Reinstall the panel

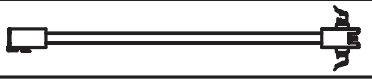



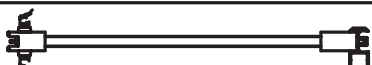
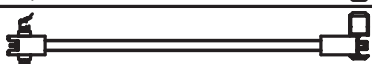

Note: There is a flat edge and a slanted edge of the interlock screw cover, be sure that the slanted edge is on the opposite side of the interlock hook. When attaching the interlock screw cover make sure not to cover the top panel notch. Covering the top panel notch will not allow the reinstallation of the panel. Last, changing the stack will not change a fixed panel to an operable panel (an XO will be still be an XO).

If you require additional help in reversing the stack or changing the configuration, please contact a PGT Sales or Customer Service Representative.



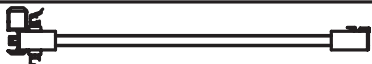

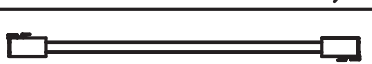
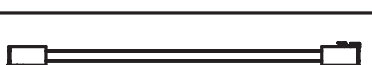

OPERABLE - PANEL TYPES

PANEL LETTER			
K	SINGLE INTERLOCK		LOCKSTILE
U <small>(BOX OUT)</small>	ASTRAGAL OUT		LOCKSTILE
U <small>(BOX IN)</small>	ASTRAGAL IN		LOCKSTILE
A	SINGLE INTERLOCK		LOCKSTILE
D	LOCKSTILE		SINGLE INTERLOCK
J <small>(BOX OUT)</small>	LOCKSTILE		ASTRAGAL OUT
J <small>(BOX IN)</small>	LOCKSTILE		ASTRAGAL IN
M	LOCKSTILE		SINGLE INTERLOCK

INTERMEDIATE - PANEL TYPES

PANEL LETTER			
L <small>(BOX OUT)</small>	SINGLE INTERLOCK		ASTRAGAL OUT
LR <small>(BOX OUT)</small>	ASTRAGAL OUT		SINGLE INTERLOCK
N <small>(BOX OUT)</small>	ASTRAGAL IN		SINGLE INTERLOCK
C <small>(BOX IN)</small>	SINGLE INTERLOCK		ASTRAGAL IN
B	SINGLE INTERLOCK		SINGLE INTERLOCK
F	SINGLE INTERLOCK		SINGLE INTERLOCK
E	SINGLE INTERLOCK		SINGLE INTERLOCK

FIXED - PANEL TYPES

PANEL LETTER			
P	SINGLE INTERLOCK		FIXED LOCKSTILE
R	FIXED LOCKSTILE		SINGLE INTERLOCK
T (BOX OUT)	ASTRAGAL OUT		FIXED LOCKSTILE
T (BOX IN)	ASTRAGAL IN		FIXED LOCKSTILE
S (BOX OUT)	FIXED LOCKSTILE		ASTRAGAL OUT
S (BOX IN)	FIXED LOCKSTILE		ASTRAGAL IN

TYPE	STANDARD	REVERSE
2P3T XX BOX SCREEN		
3P3T OXO BOX SCREEN		
3P4T XXX BOX SCREEN		
3P5T XXX BOX SCREEN		
4P3T OXOX BOX SCREEN		SAME AS STANDARD STACK
4P5T XXXX BOX SCREEN		
4P7T XXXX BOX SCREEN		
TYPE	STANDARD STACK	
6P5T OXXXXO BOX SCREEN		
8P7T OXXXXXXO BOX SCREEN		

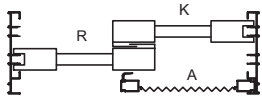
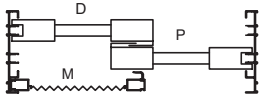
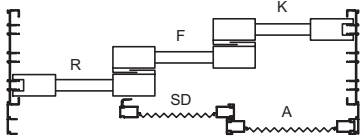
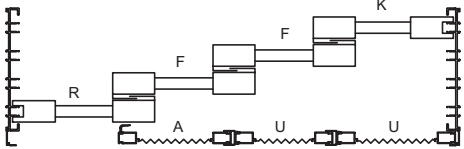
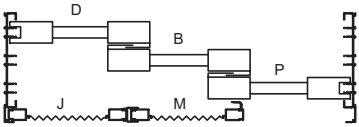
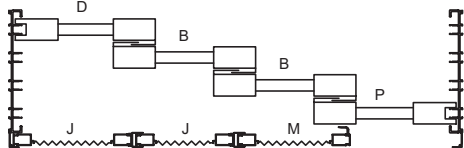
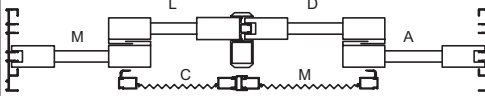
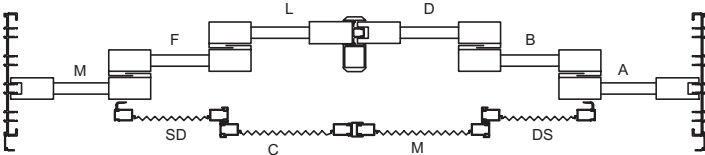
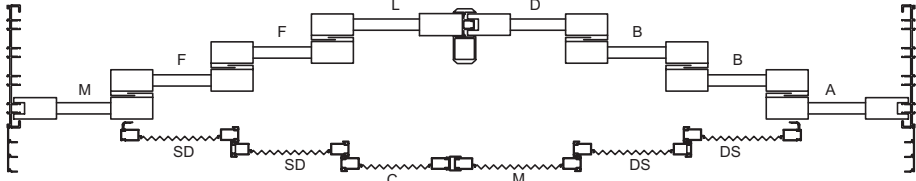
TYPE	STANDARD	REVERSE
2P3T OX BOX SCREEN	N/A ORDER AS XO	
2P2T XO BOX SCREEN		N/A ORDER AS OX
3P4T OXX BOX SCREEN	N/A ORDER AS XXO	
4P5T OXXX BOX SCREEN	N/A ORDER AS XXXO	
3P4T XXO BOX SCREEN		N/A ORDER AS OXX
4P5T XXXO BOX SCREEN		N/A ORDER AS OXXX
4P3T XXXX BOX SCREEN		SAME AS STANDARD STACK
TYPE	STANDARD STACK	
6P5T XXXXXX BOX SCREEN		
8P7T XXXXXXXXX BOX SCREEN		

LEFT HAND POCKETS

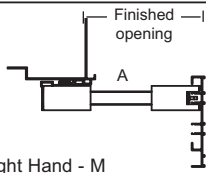

Panel type for Right Hand - M

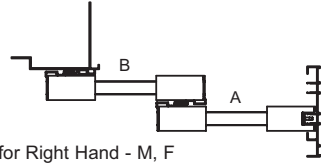

Panel type for Right Hand - M, F

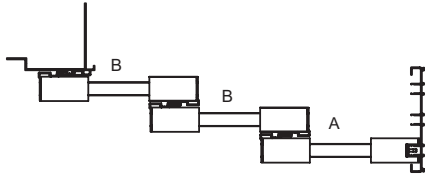

Panel type for Right Hand - M, F, F

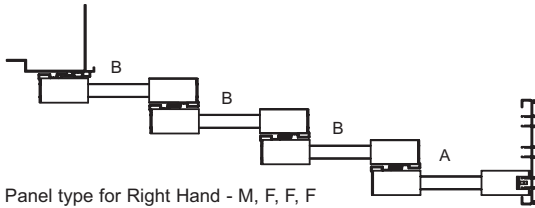

Panel type for Right Hand - M, F, F, F

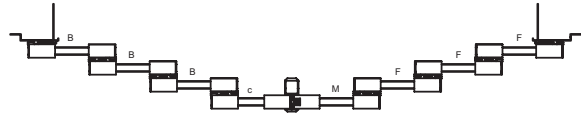
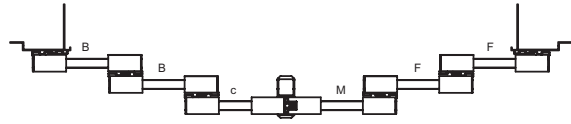
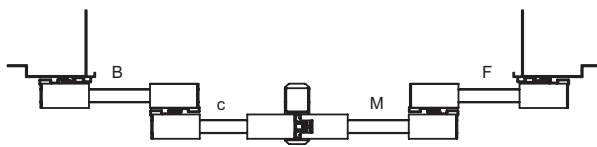
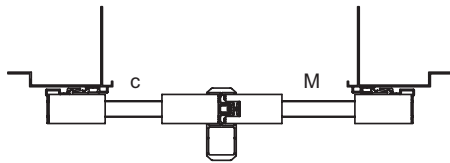

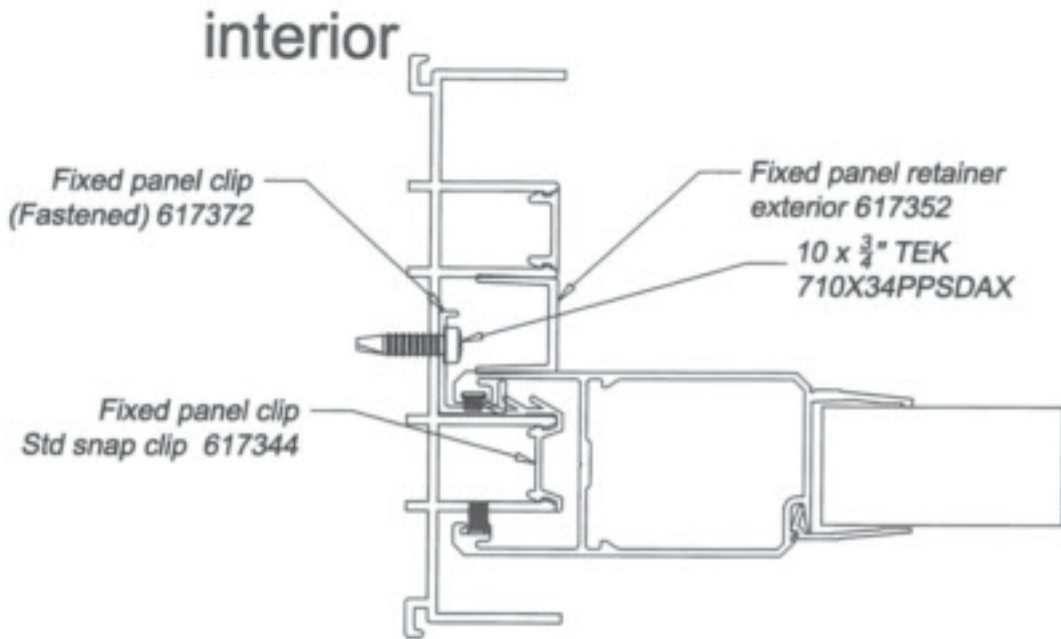

fig. w/ fixed on
Exterior track

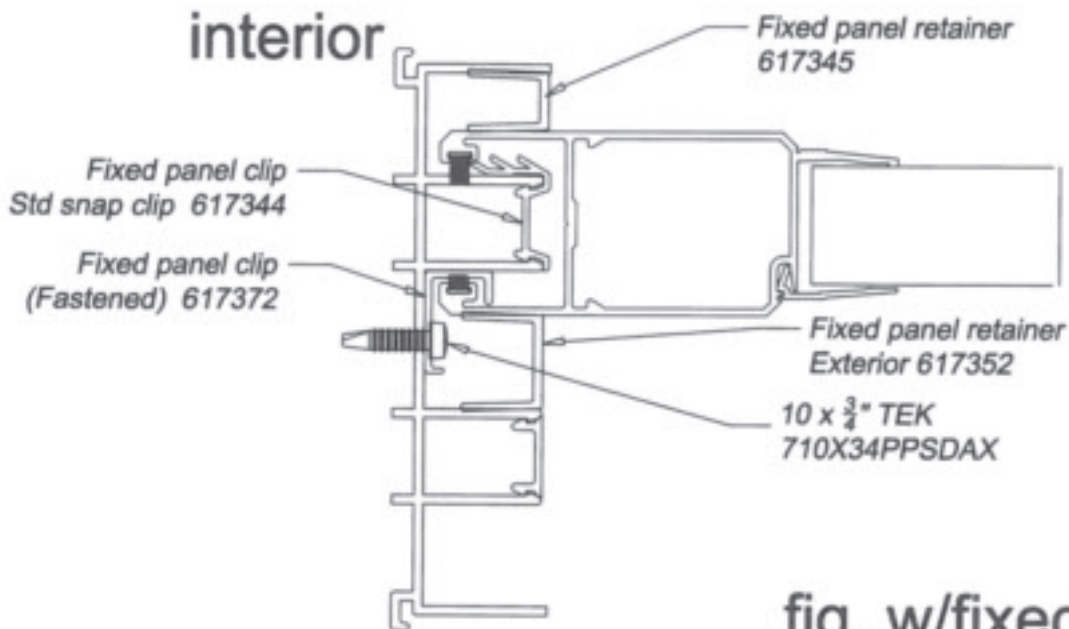

fig. w/ fixed on
Interior track

MUST BE USED IN CONJUNCTION W/ EXISTING
STANDARD SNAP CLIP AT JAMB CENTER.



CUSTOM WINDOWS + DOORS



PGTINDUSTRIES.COM | N. VENICE, FL
©2018 PGT CUSTOM WINDOWS + DOORS
03/2018 MB0200341